

 LORENZOLINE

**24GS**

Glass Sliding System | Cam Sürme Sistemi

PROFILES  
PROFILLER

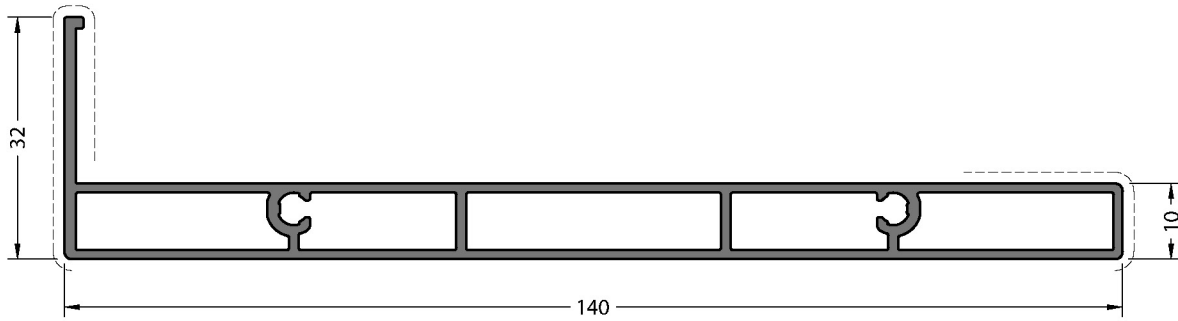

**CODE / KOD**  
**24GS-101-00** **THEORETICAL WEIGHT kg/m**  
 TEORİK AĞIRLIK kg/m  
**1.205**

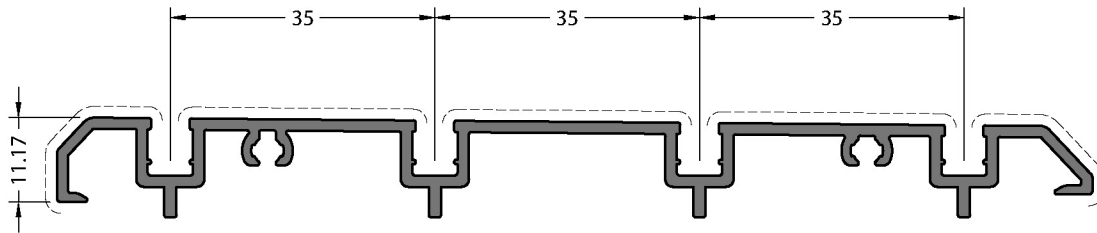

**CODE / KOD**  
**24GS-102-00** **THEORETICAL WEIGHT kg/m**  
 TEORİK AĞIRLIK kg/m  
**1.003**

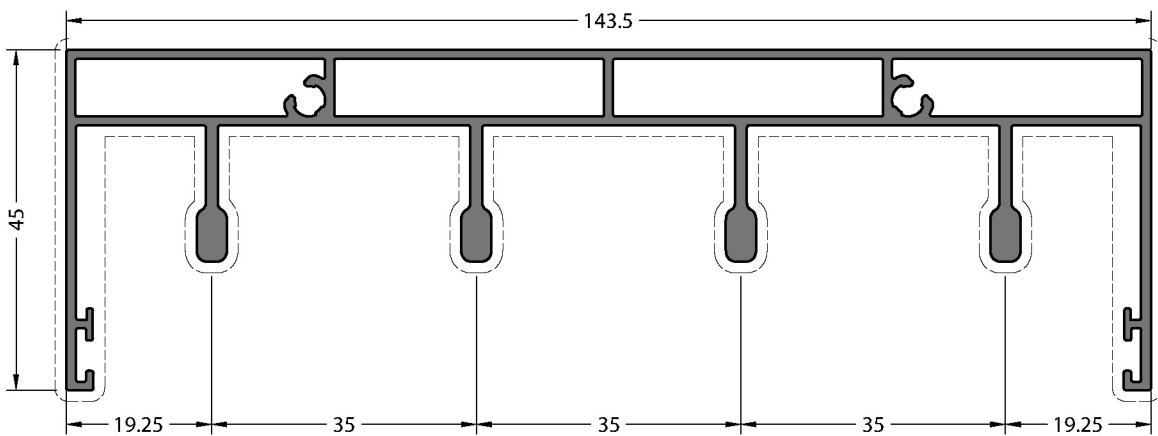

**CODE / KOD**  
**24GS-103-00** **THEORETICAL WEIGHT kg/m**  
 TEORİK AĞIRLIK kg/m  
**1.875**

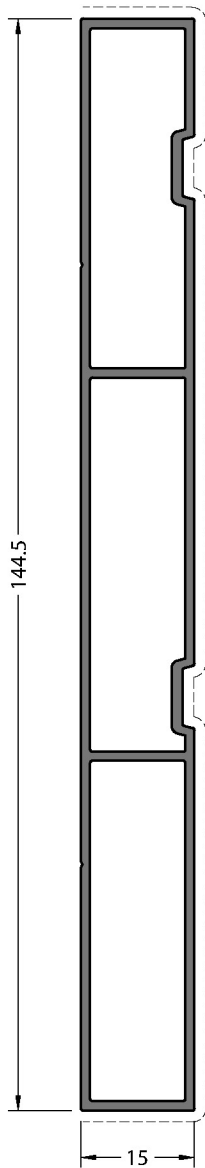

**CODE / KOD**  
**24GS-104-00**

**THEORETICAL WEIGHT kg/m**  
TEORİK AĞIRLIK kg/m  
**1.131**

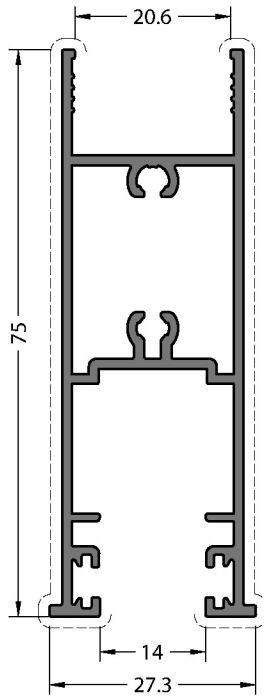

**CODE / KOD**  
**24GS-201-00**

**THEORETICAL WEIGHT kg/m**  
TEORİK AĞIRLIK kg/m  
**0.885**

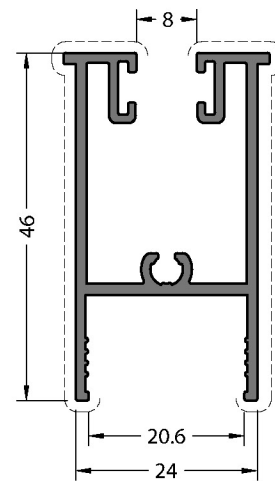

**CODE / KOD**  
**24GS-202-00**

**THEORETICAL WEIGHT kg/m**  
TEORİK AĞIRLIK kg/m  
**0.600**

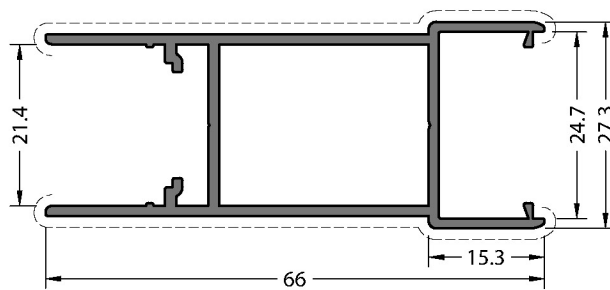

**CODE / KOD**  
**24GS-203-00**

**THEORETICAL WEIGHT kg/m**  
TEORİK AĞIRLIK kg/m  
**0.677**

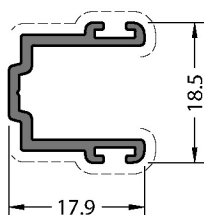

**CODE / KOD**  
**24GS-213-00**

**THEORETICAL WEIGHT kg/m**  
TEORİK AĞIRLIK kg/m  
**0.194**

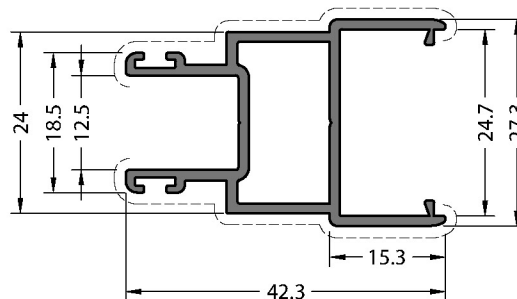

**CODE / KOD**  
**24GS-204-00**

**THEORETICAL WEIGHT kg/m**  
TEORİK AĞIRLIK kg/m  
**0.506**

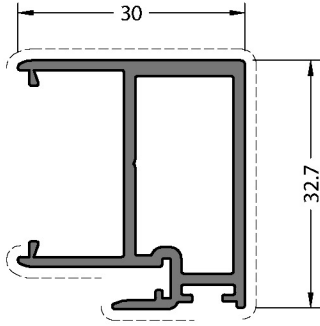

**CODE / KOD**  
**24GS-501-00**

**THEORETICAL WEIGHT kg/m**  
TEORİK AĞIRLIK kg/m  
**0.534**

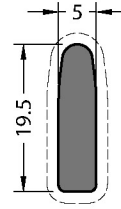

**20 Micron Anodized.**  
20 Mikron Eloksal.

**CODE / KOD**  
**24GS-901-00**

**THEORETICAL WEIGHT kg/m**  
TEORİK AĞIRLIK kg/m  
**0.247**

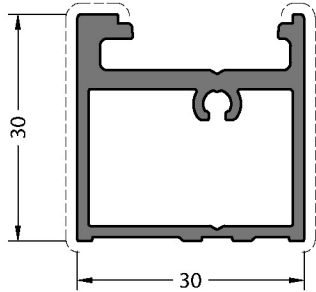

**CODE / KOD**  
**07-125-00**

**THEORETICAL WEIGHT kg/m**  
TEORİK AĞIRLIK kg/m  
**0.651**

DETAILS  
DETAYLAR





**OUTSIDE / DIŐ**

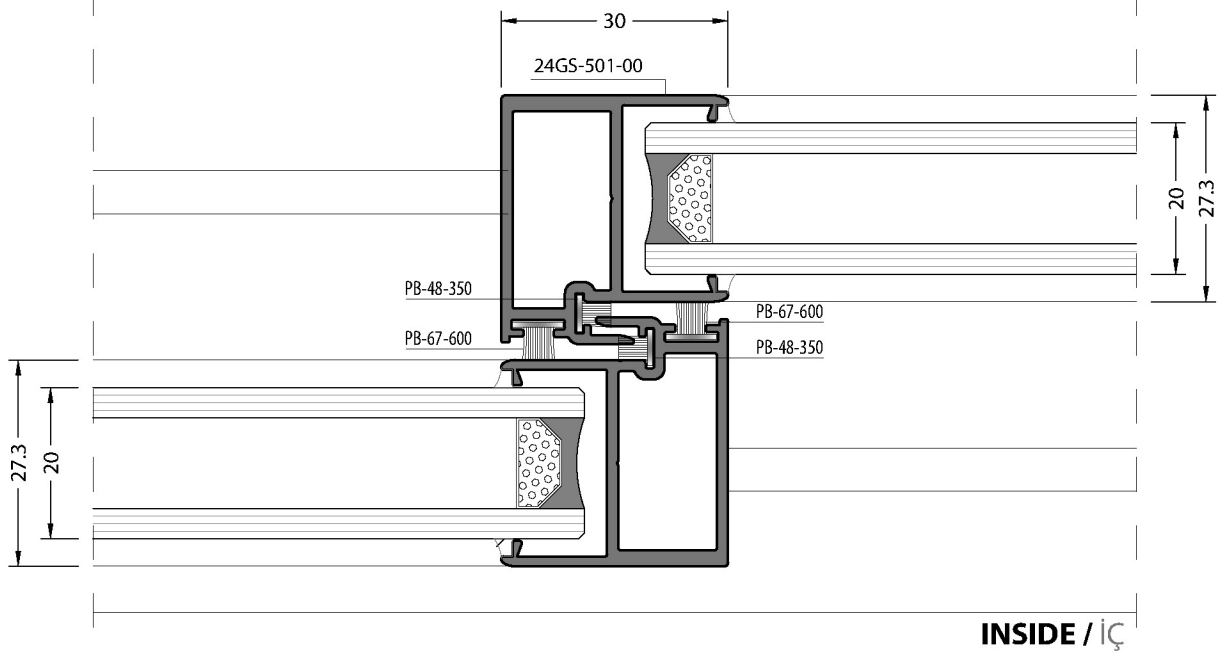

**INSIDE / İÇ**



**OUTSIDE / DIŐ**

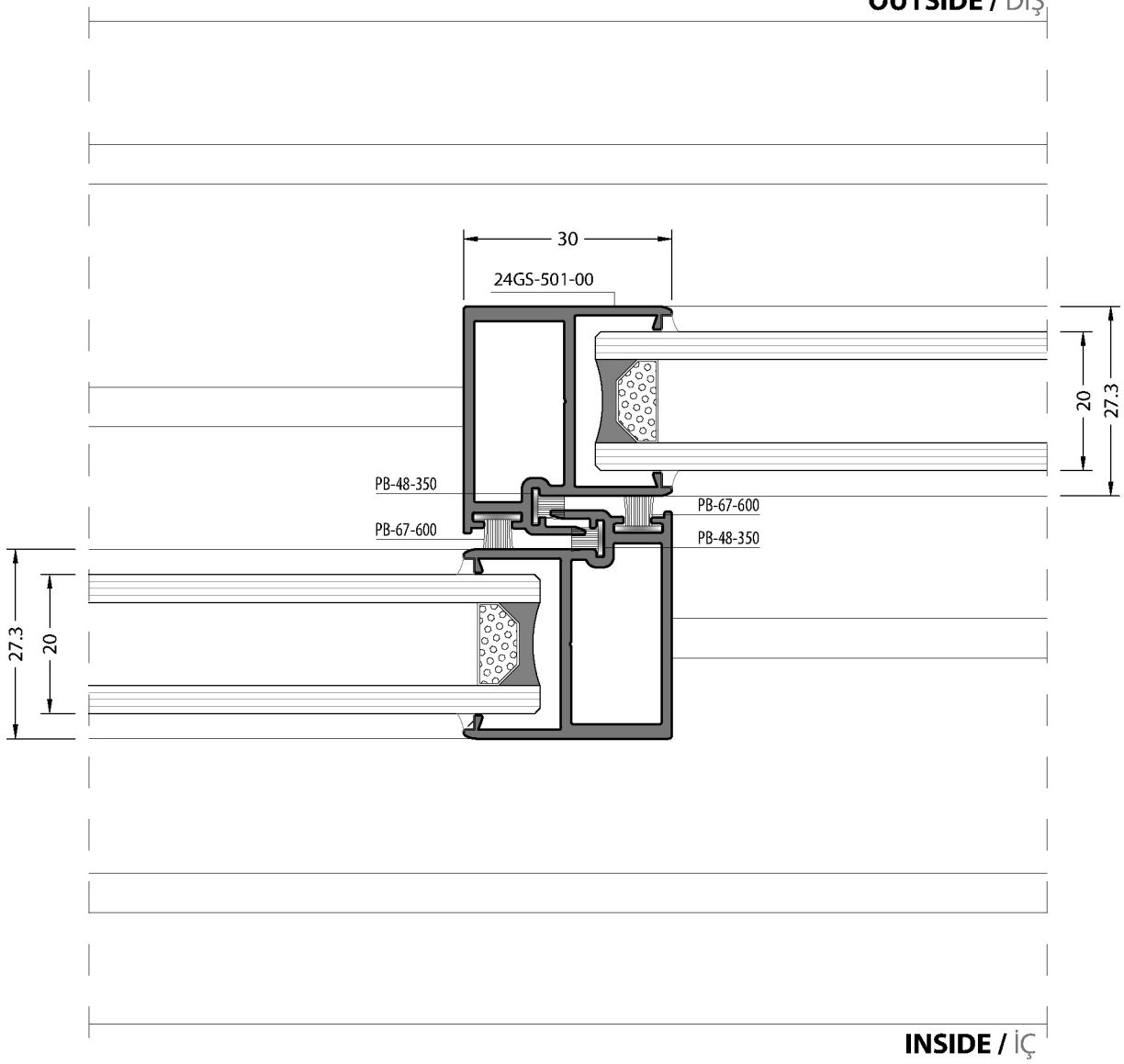

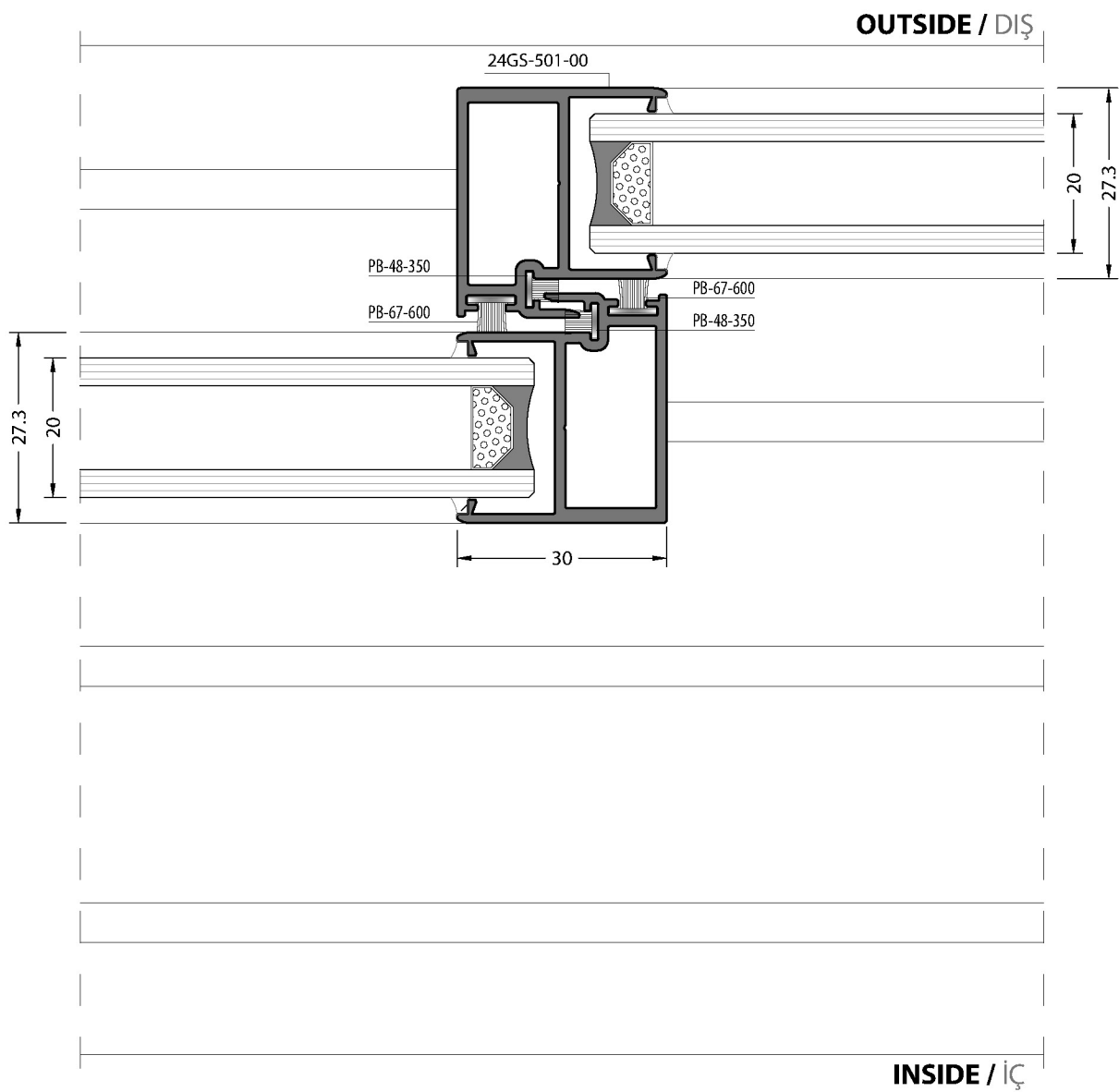
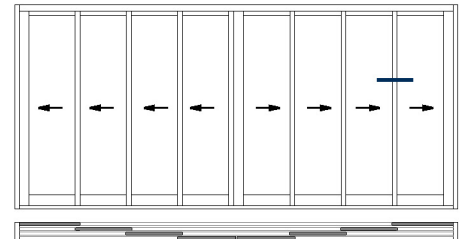

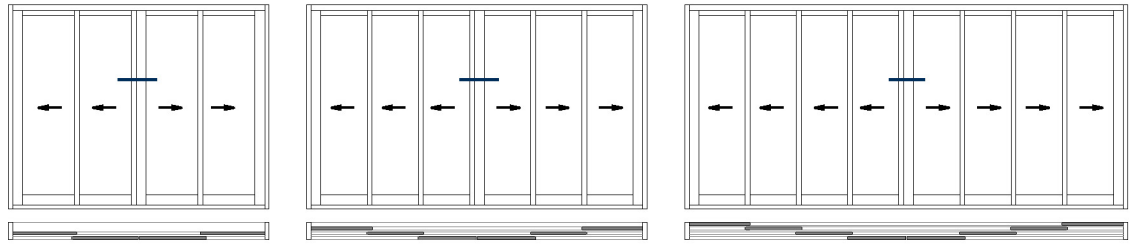

**OUTSIDE / DIŞ**

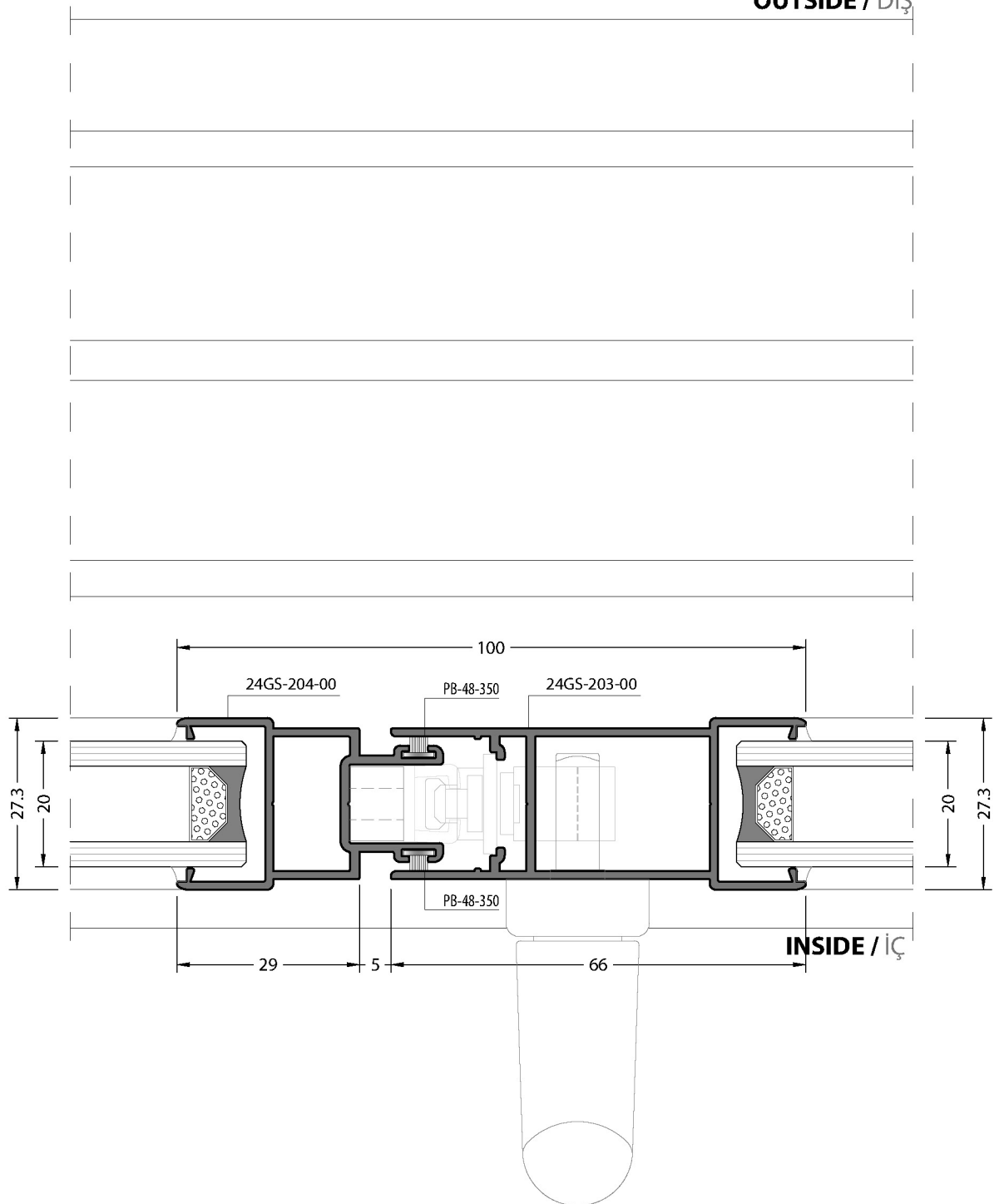

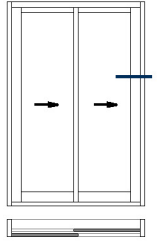

**OUTSIDE / DIŞ**

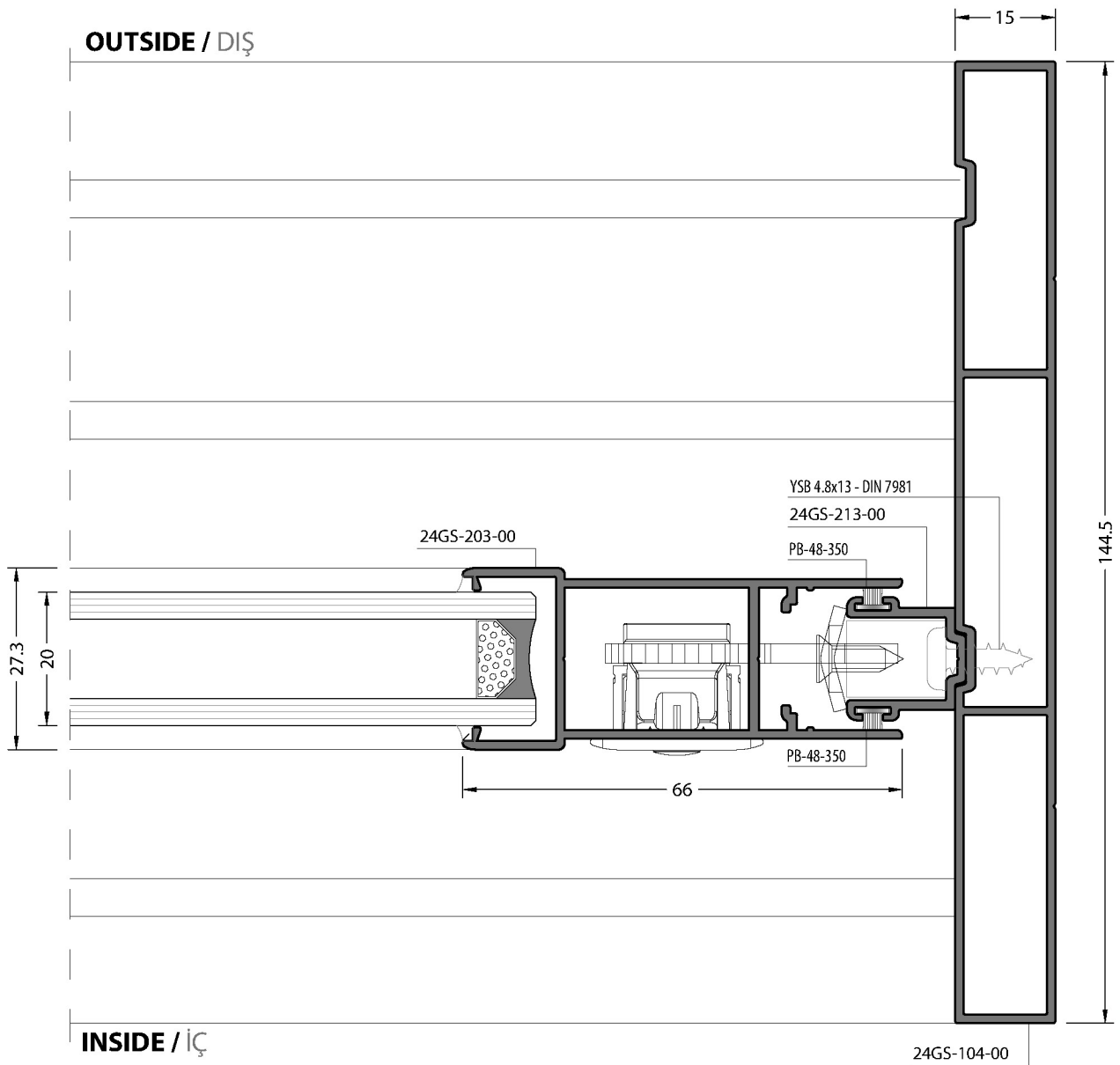

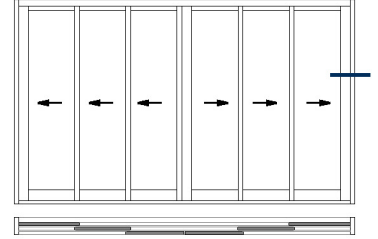
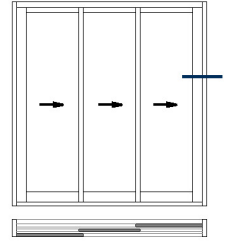

24GS-104-00

**OUTSIDE / DIŞ**

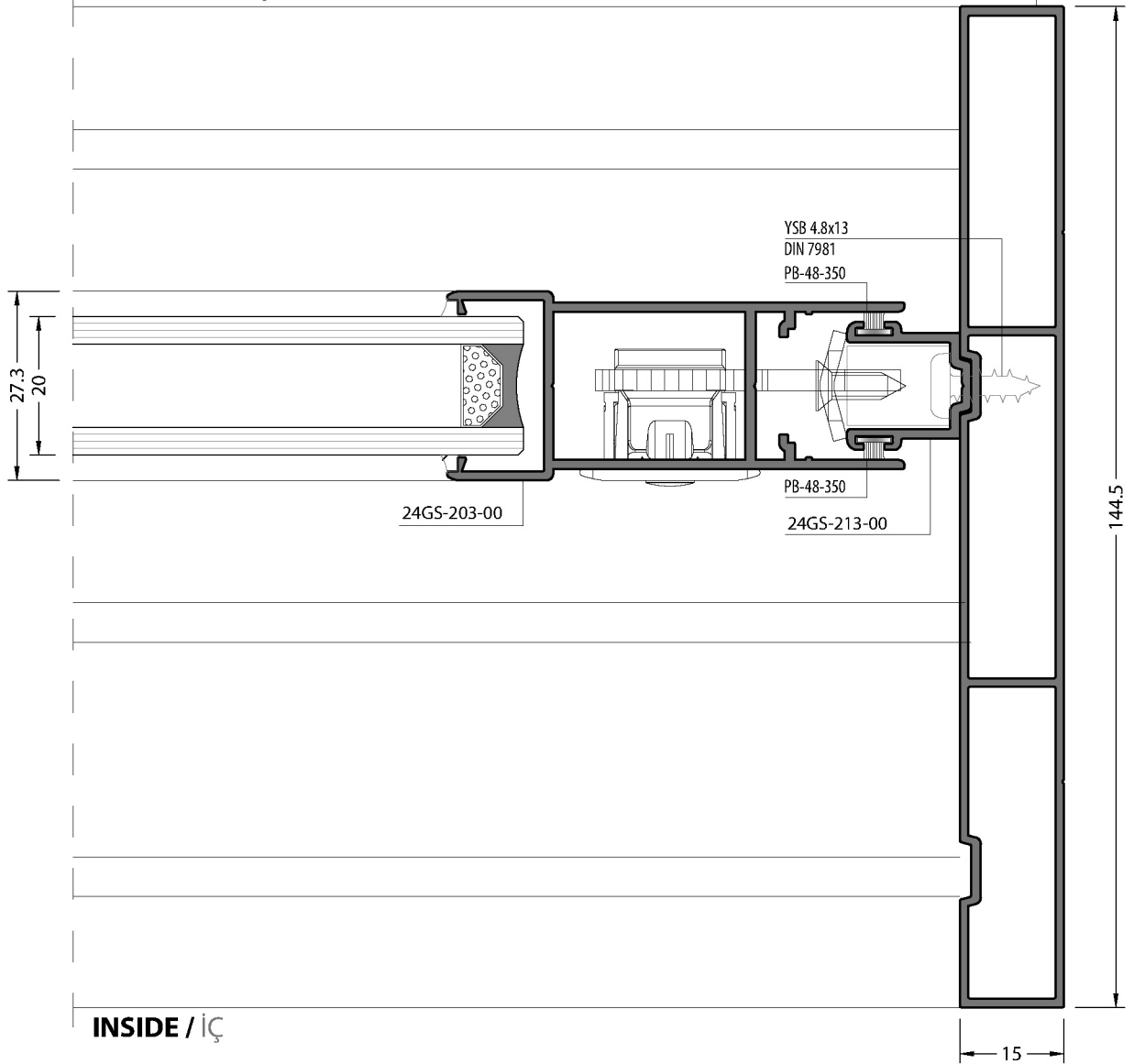

**INSIDE / İÇ**

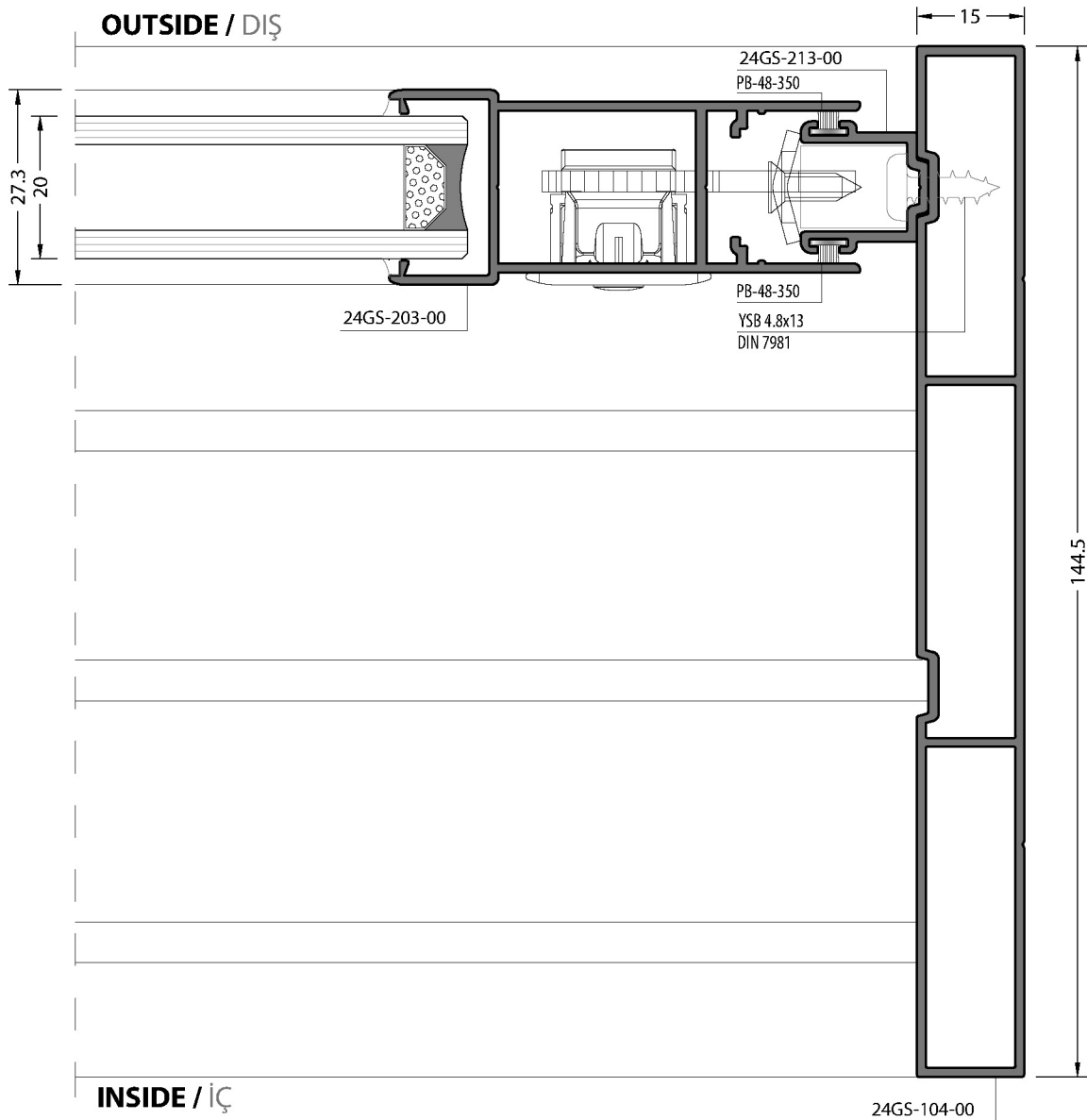
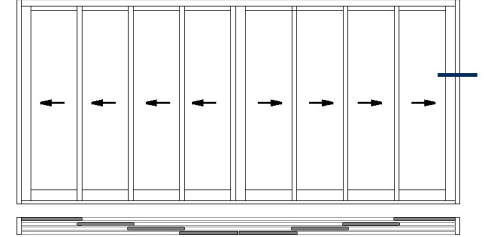
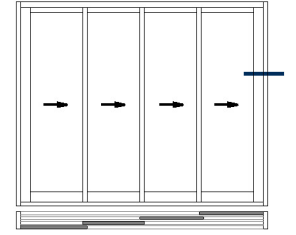

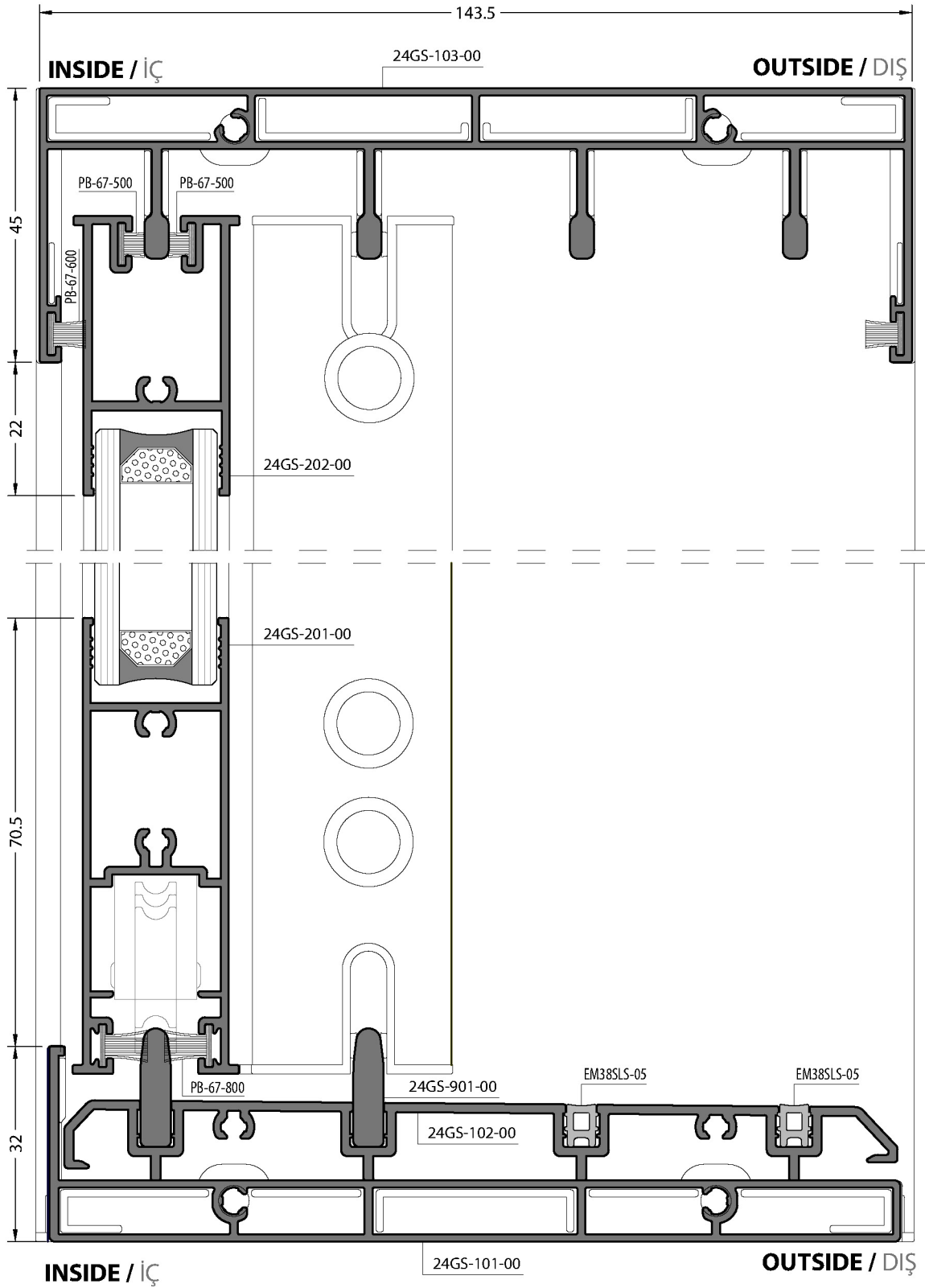
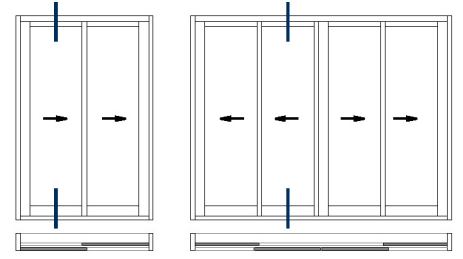

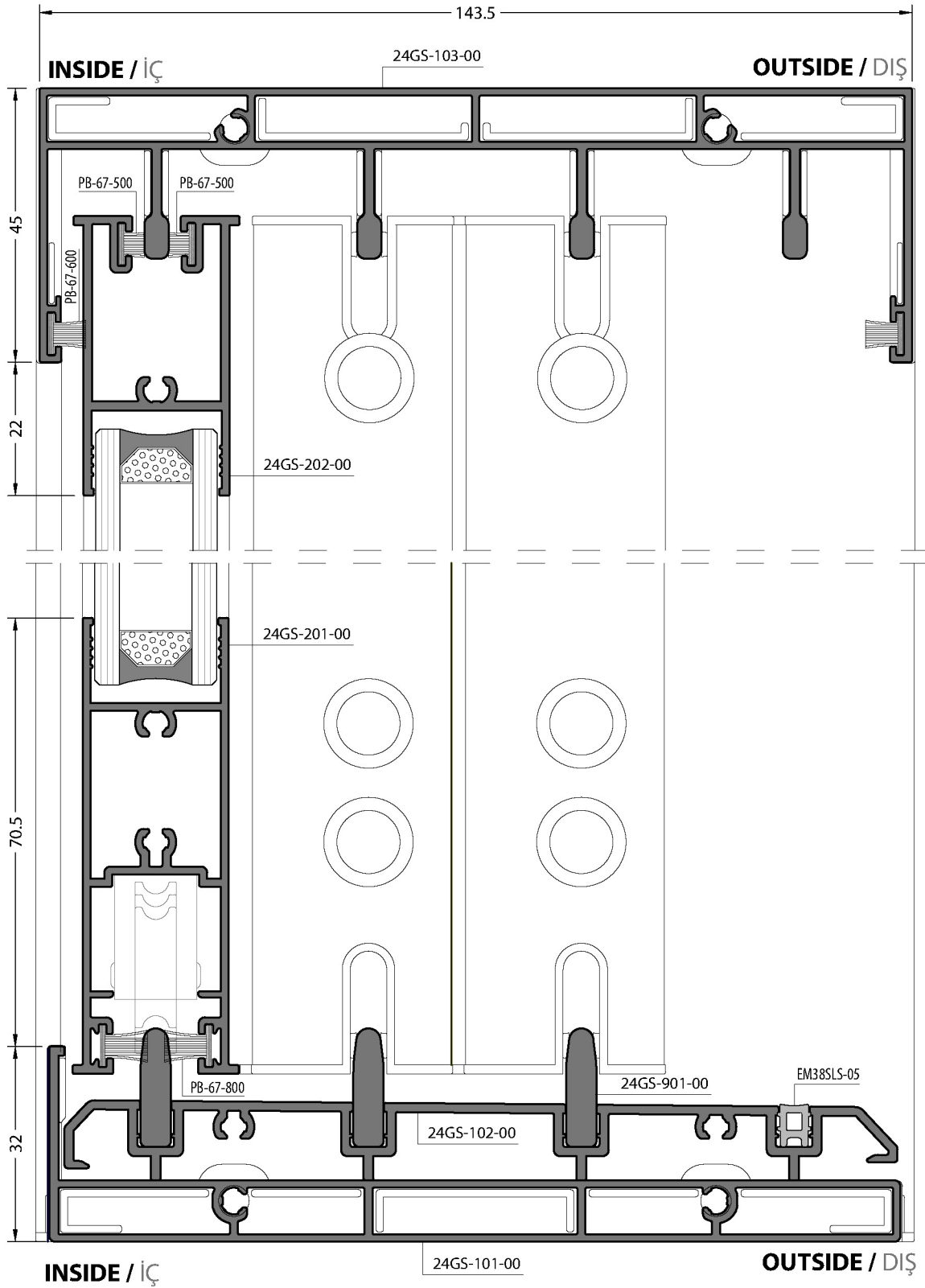
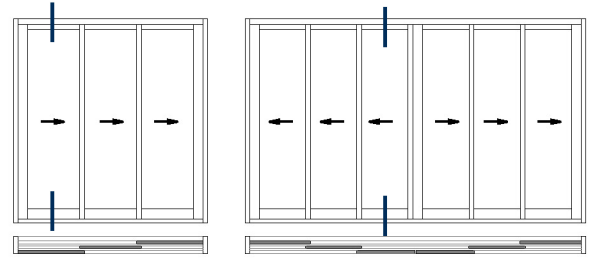

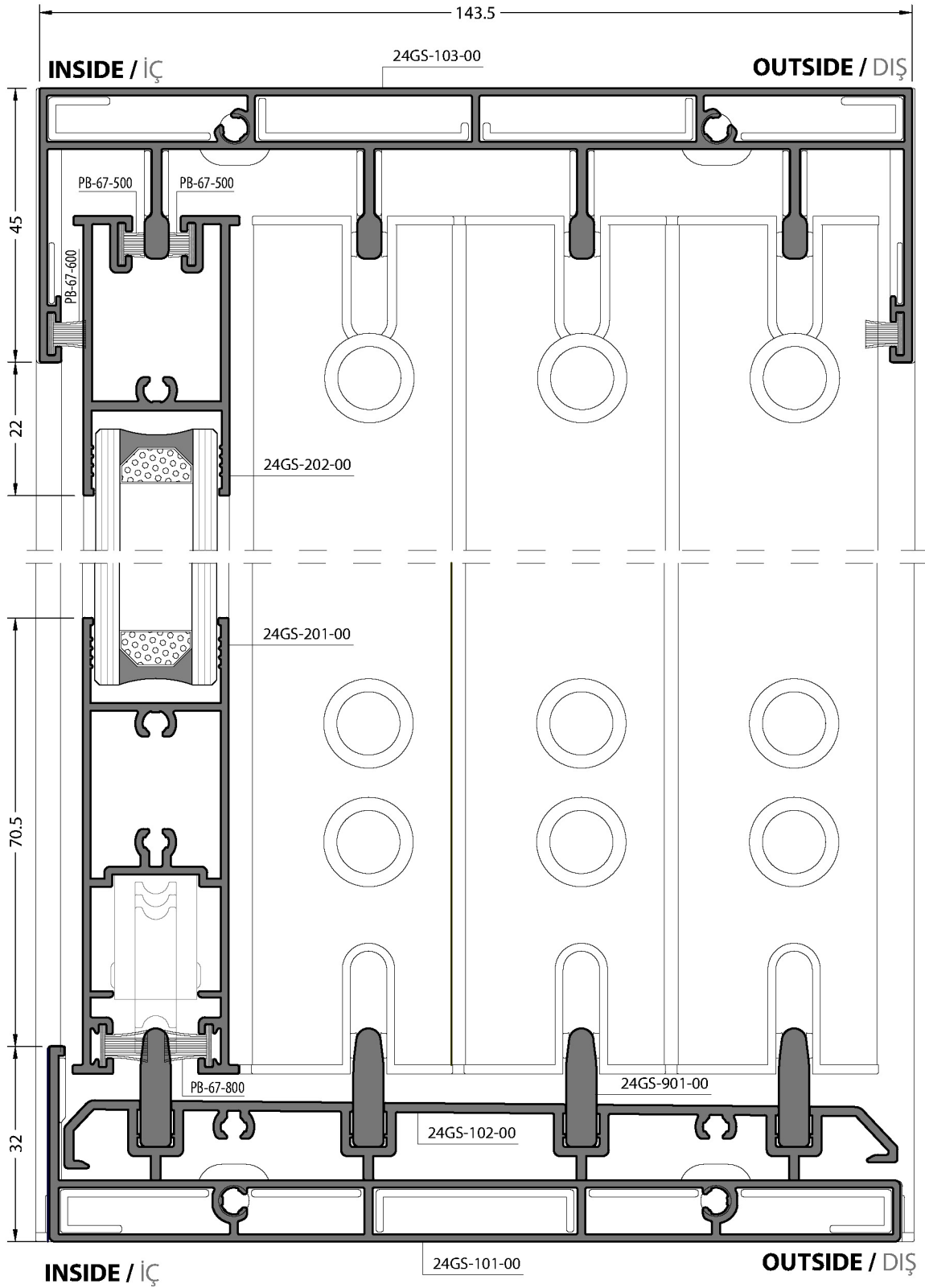
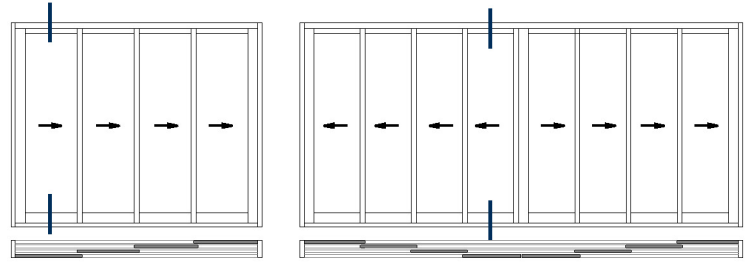





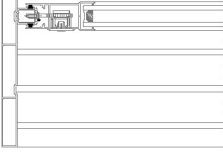

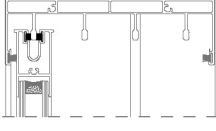

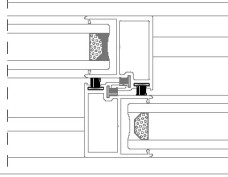

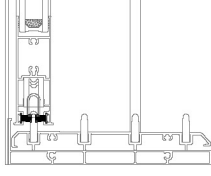

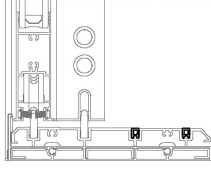

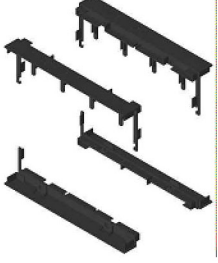





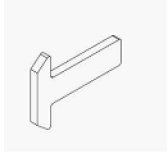

ACCESSORIES  
AKSESUARLAR

**GASKETS / FİTİLLER**

CODE / KOD	DRAWING / ÇİZİM	APPLICATION / UYGULAMA	DESCRIPTION AÇIKLAMA	MATERIAL MALZEME	IN ONE PACKAGE PAKET MİKTARI
PB-48-350			<b>BRUSH FİRÇA (3.5 mm)</b>	-	- m
PB-67-500			<b>BRUSH FİRÇA (5 mm)</b>	-	- m
PB-67-600			<b>BRUSH FİRÇA (6 mm)</b>	-	- m
PB-67-800			<b>BRUSH FİRÇA (8 mm)</b>	-	- m
EM38SLS-05			<b>FRAME GASKET KASA FİTİLİ</b>	EPDM	500 m

PACKAGE CODE PAKET KOD	VIEW RESİM	DESCRIPTION AÇIKLAMA	PACKAGE CODE PAKET KOD	VIEW RESİM	DESCRIPTION AÇIKLAMA
EM24GS-104		<b>FRAME CORNER CONNECTION PLASTIC SET</b> KASA KÖŞE BİRLEŞİM PLASTİK TAKIMI	EM24GS-204		<b>HEAD TO HEAD CONNECTION PLASTIC SET</b> KAFA KAFAYA PLASTİK TAKIMI
EM24GS-201		<b>SASH CONNECTION PLASTIC SET</b> KANAT BİRLEŞİM PLASTİK TAKIMI	EM24GS-213		<b>FRAME ISOLATION PLASTIC SET</b> KASA İZOLASYON PLASTİK TAKIMI
EM24GS-501		<b>CLAMP CONNECTION PLASTIC SET</b> KENET BİRLEŞİM PLASTİK TAKIMI			

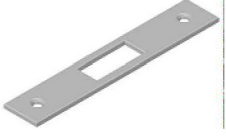
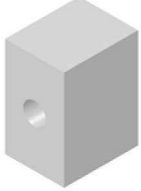
PACKAGE CODE PAKET KOD	VIEW RESİM	DESCRIPTION AÇIKLAMA	QUANTITY MİKTAR
041.01.1113		<b>XXXXXXXX</b> CAM SÜRME RULMAN	1 Piece / Adet
020.98.3500		<b>XXXXXXXX</b> HAVUZ KOL	1 Piece / Adet
001.24.0001		<b>XXXXXXXX</b> SÜRME DİL (50 mm)	1 Piece / Adet
008.06.8113		<b>XXXXXXXX</b> SH-8113 ÇEKME C KOL RAL 9005	1 Piece / Adet
023.51.2000		<b>XXXXXXXX</b> 2000 mm SÜRME İSPANYOLET	1 Piece / Adet
001.24.0002		<b>XXXXXXXX</b> HAVUZ KOL VE İSPANYOLET KARŞILIK	1 Piece / Adet
008.25.9005		<b>XXXXXXXX</b> RAGNİ 360 MARTELLİNA HANDLE RAL 9005	1 Piece / Adet

PACKAGE CODE PAKET KOD	VIEW RESİM	DESCRIPTION AÇIKLAMA	QUANTITY MIKTAR
010.09.1201		<b>XXXXXXX</b> KALE 201 KİLİT	1 Piece / Adet
		<b>XXXXXXX</b> KALE KİLİT KARŞILIK	1 Piece / Adet
CA-010.09.1201		<b>XXXXXXX</b> KALE KİLİT ARKALIĞI	1 Piece / Adet
<b>EM09-0001</b>		<b>CAP</b> KAPAK	1 Piece / Adet

CUTTING SIZE  
KESİM ÖLÇÜLERİ

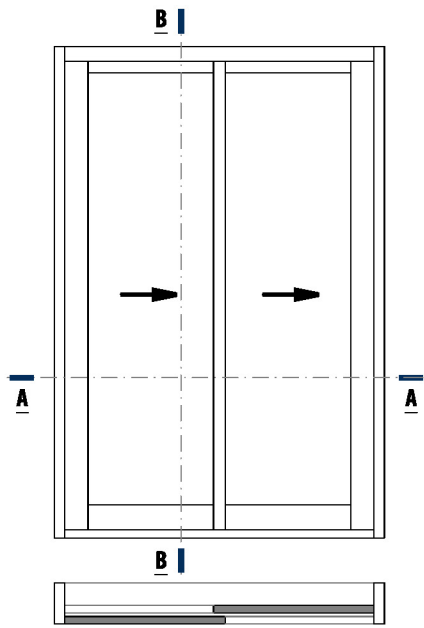

✓ Please look at the assembly drawings for mechanical treatment.  
Mekanik işlemler için lütfen uygulama detayları bölümüne bakınız.

SASH GLASS / KANAT CAMI

Code Kod	Drawing Çizim	Quantity Miktar	Dimensions (mm) Boyutlar
GLASS CAM		2 Pcs / Adet	GL = SL - 6 GH = FH - 148

PROFILES / PROFİLLER

Code Kod	Drawing Çizim	Cut Kesim	Quantity Miktar	Dimensions (mm) Boyutlar	Mechanical Treatment Mekanik İşlem
24GS-103-00			1 Pcs / Adet	FL1 = FL - 33	-
24GS-102-00			1 Pcs / Adet	FL1 = FL - 30	-
24GS-101-00			1 Pcs / Adet	FL1 = FL - 33	-
24GS-104-00			2 Pcs / Adet	FH - 3	-
24GS-201-00			2 Pcs / Adet	SL = (FL-152)/2	-
24GS-202-00			2 Pcs / Adet	SL = (FL-152)/2	-
24GS-203-00			2 Pcs / Adet	FH - 51.5	-
24GS-213-00			2 Pcs / Adet	FH - 32	-
24GS-501-00			2 Pcs / Adet	FH - 51.5	-
24GS-901-00			2 Pcs / Adet	FL - 30	-

CONSUMABLE MATERIALS / SARF MALZEMELER

Code Kod	Description Açıklama	Quantity (pcs-m) Miktar (Paket)	Picture Resim
EM24GS-104	FRAME CORNER CONNECTION PLASTIC SET KASA KÖŞE BİRLEŞİM PLASTİK TAKIMI	1 Set / Takım	
EM24GS-201	SASH CONNECTION PLASTIC SET KANAT BİRLEŞİM PLASTİK TAKIMI	2 Set / Takım	
EM24GS-501	CLAMP CONNECTION PLASTIC SET KENET BİRLEŞİM PLASTİK TAKIMI	2 Set / Takım	
EM24GS-213	FRAME ISOLATION PLASTIC SET KASA İZOLASYON PLASTİK TAKIMI	2 Set / Takım	
EM09-0001	CAP / KAPAK	6 Pcs / Adet	

GASKETS / FİTİLLER

Code Kod	Picture Resim	Quantity Miktar
PB-48-350		6 (FH-50)
PB-67-500		4 SL
PB-67-600		2 FL + 2 (FH-50)
PB-67-800		4 SL
EM38SLS-05		2 FL

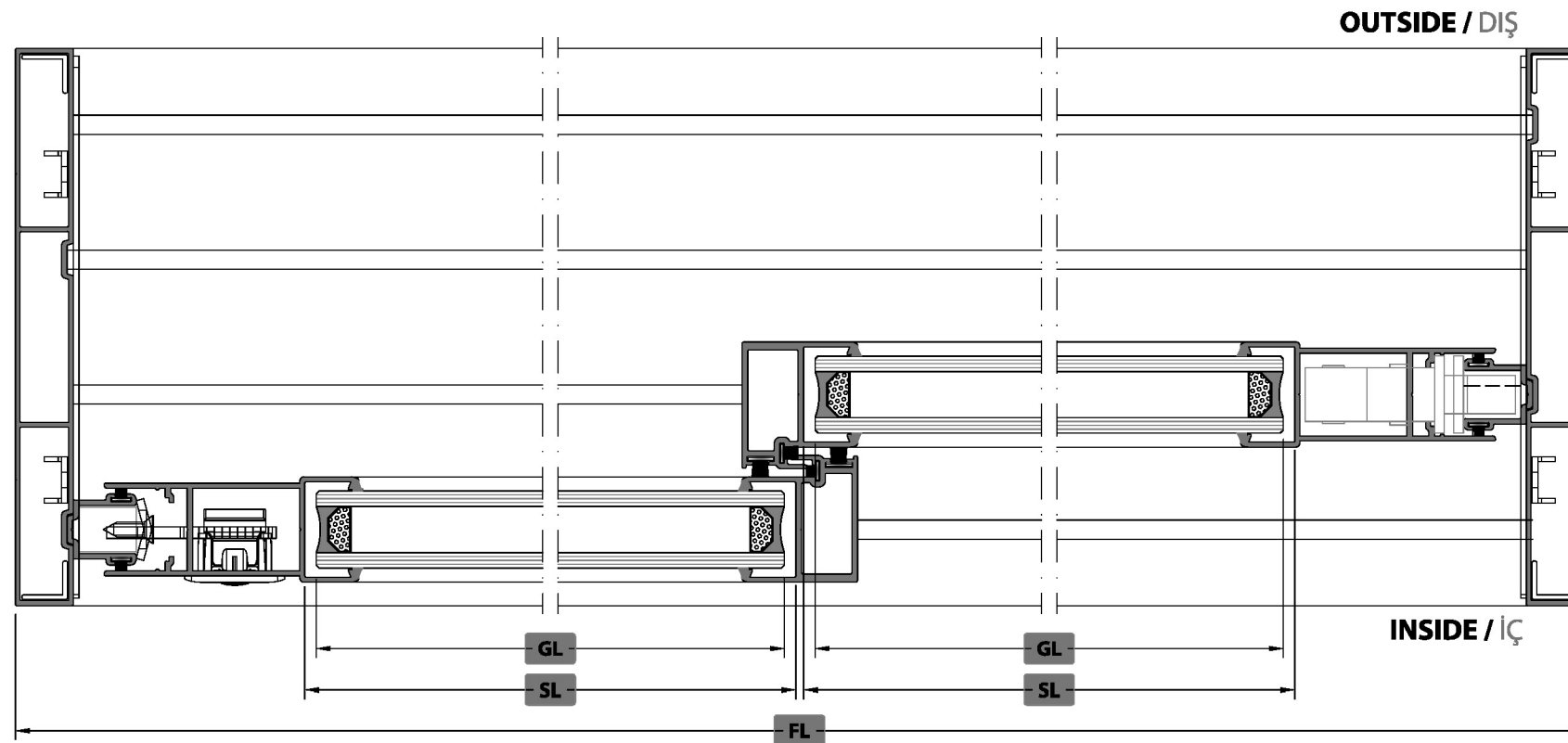
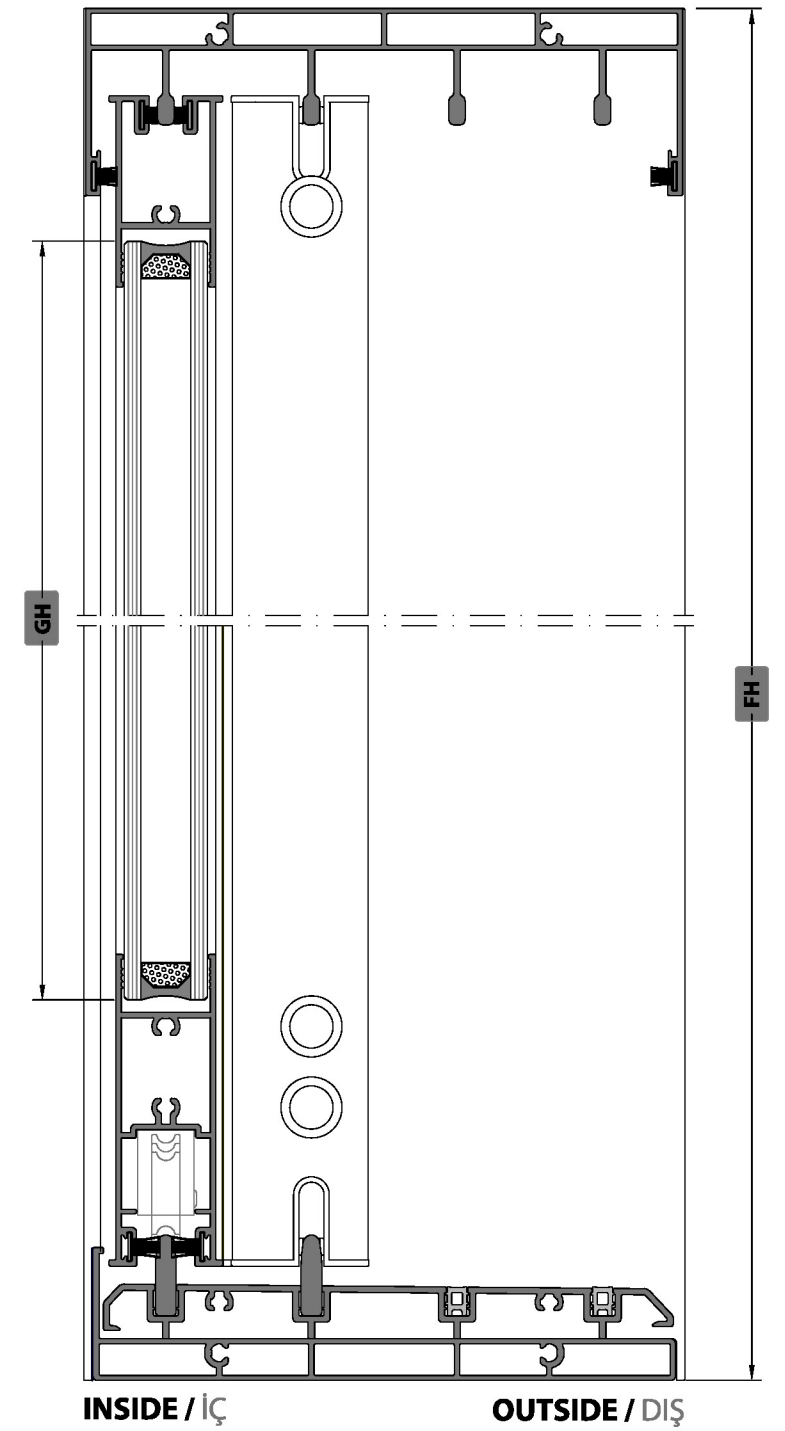

OUTSIDE / DIŞ

INSIDE / İÇ

INSIDE / İÇ

OUTSIDE / DIŞ

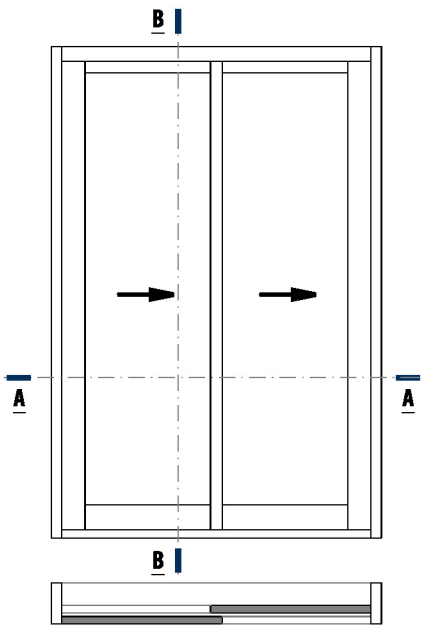

✓ Please look at the assembly drawings for mechanical treatment.  
Mekanik işlemler için lütfen uygulama detayları bölümüne bakınız.

**SASH GLASS / KANAT CAMI**

Code Kod	Drawing Çizim	Quantity Miktar	Dimensions (mm) Boyutlar
GLASS CAM		2 Pcs / Adet	GL = SL - 6 GH = FH - 138

**PROFILES / PROFİLLER**

Code Kod	Drawing Çizim	Cut Kesim	Quantity Miktar	Dimensions (mm) Boyutlar	Mechanical Treatment Mekanik İşlem
24GS-103-00			1 Pcs / Adet	FL1 = FL - 33	-
24GS-102-00			1 Pcs / Adet	FL1 = FL - 30	-
24GS-104-00			2 Pcs / Adet	FH - 1.5	-
24GS-201-00			2 Pcs / Adet	SL = (FL-152)/2	-
24GS-202-00			2 Pcs / Adet	SL = (FL-152)/2	-
24GS-203-00			2 Pcs / Adet	FH - 41.5	-
24GS-213-00			2 Pcs / Adet	FH - 22	-
24GS-501-00			2 Pcs / Adet	FH - 41.5	-
24GS-901-00			2 Pcs / Adet	FL - 30	-

**CONSUMABLE MATERIALS / SARF MALZEMELER**

Code Kod	Description Açıklama	Quantity (pcs-m) Miktar (Paket)	Picture Resim
EM24GS-104	FRAME CORNER CONNECTION PLASTIC SET KASA KÖŞE BİRLEŞİM PLASTİK TAKIMI	1 Set / Takım	
EM24GS-201	SASH CONNECTION PLASTIC SET KANAT BİRLEŞİM PLASTİK TAKIMI	2 Set / Takım	
EM24GS-501	CLAMP CONNECTION PLASTIC SET KENET BİRLEŞİM PLASTİK TAKIMI	2 Set / Takım	
EM24GS-213	FRAME ISOLATION PLASTIC SET KASA İZOLASYON PLASTİK TAKIMI	2 Set / Takım	
EM09-0001	CAP / KAPAK	6 Pcs / Adet	

**GASKETS / FİTİLLER**

Code Kod	Picture Resim	Quantity Miktar
PB-48-350		6 (FH-40)
PB-67-500		4 SL
PB-67-600		2 FL + 2 (FH-40)
PB-67-800		4 SL
EM38SLS-05		2 FL

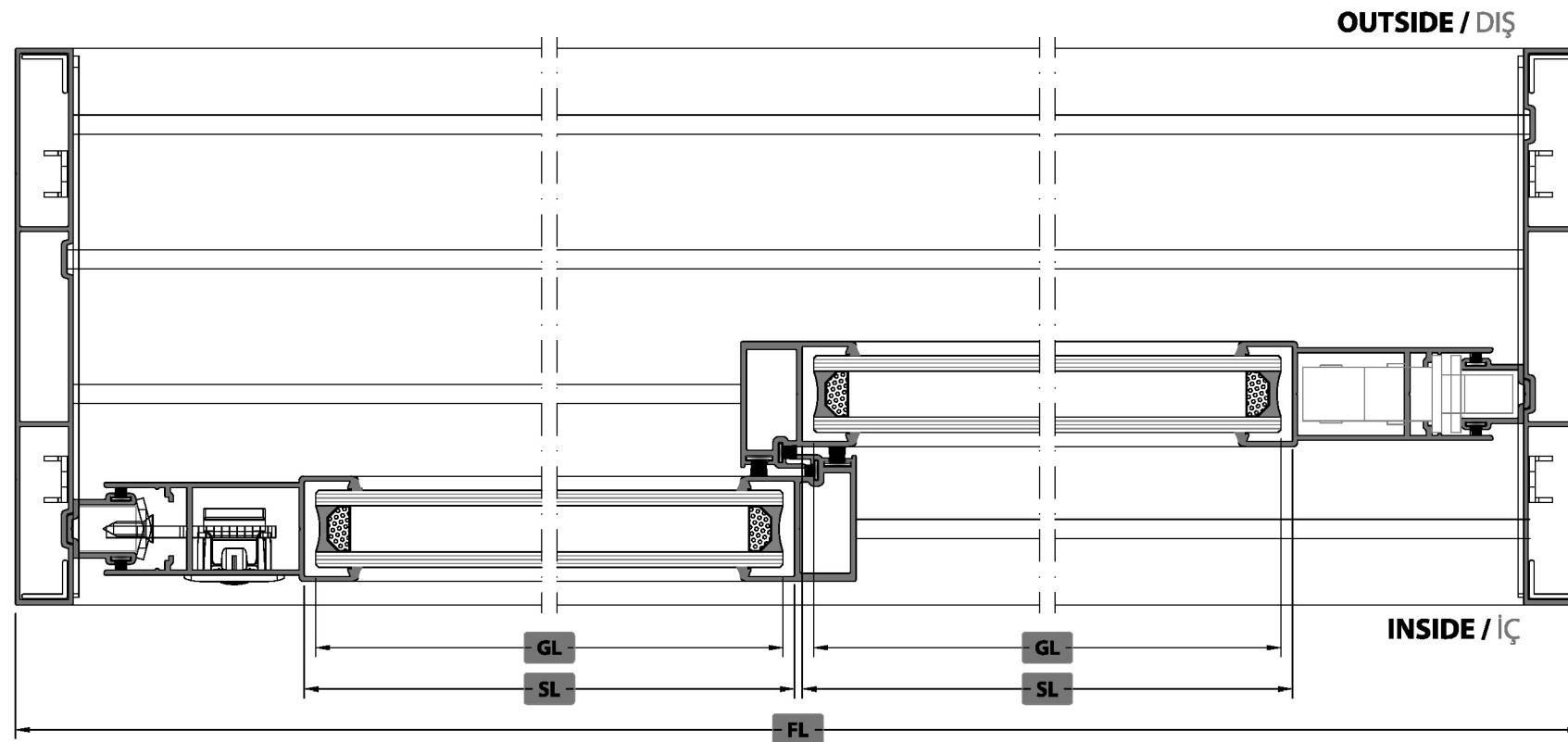
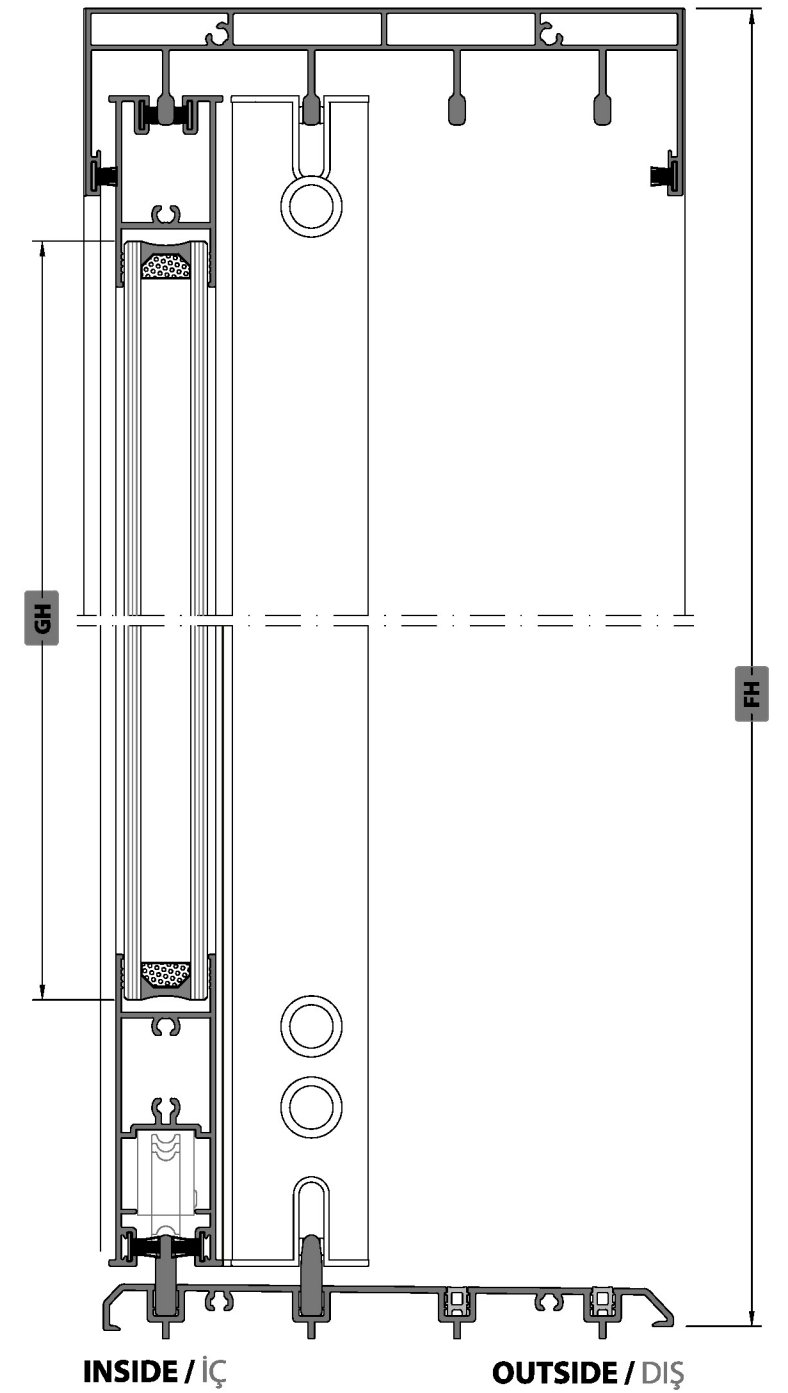

OUTSIDE / DIŞ

INSIDE / İÇ

INSIDE / İÇ

OUTSIDE / DIŞ

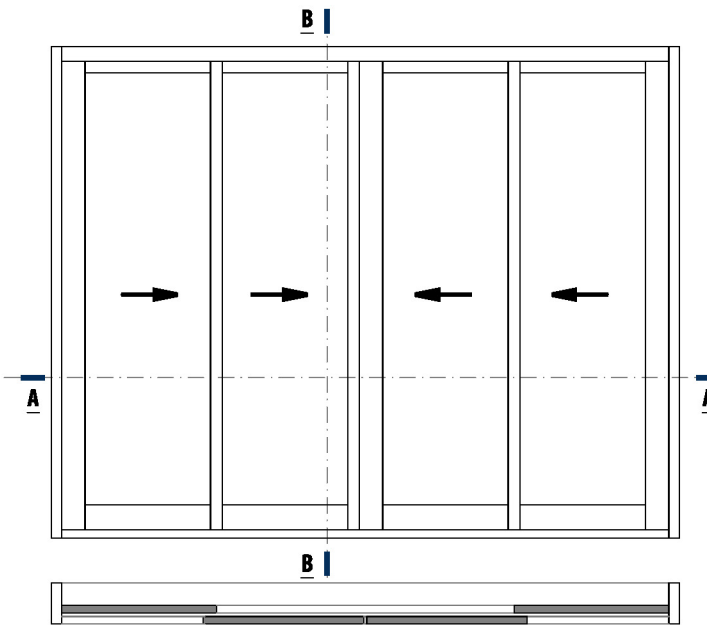

✓ Please look at the assembly drawings for mechanical treatment.  
Mekanik işlemler için lütfen uygulama detayları bölümüne bakınız.

**SASH GLASS / KANAT CAMI**

Code Kod	Drawing Çizim	Quantity Miktar	Dimensions (mm) Boyutlar
GLASS CAM		4 Pcs / Adet	GL = SL - 6 GH = FH - 148

**PROFILES / PROFİLLER**

Code Kod	Drawing Çizim	Cut Kesim	Quantity Miktar	Dimensions (mm) Boyutlar	Mechanical Treatment Mekanik İşlem
24GS-103-00			1 Pcs / Adet	FL1 = FL - 33	-
24GS-102-00			1 Pcs / Adet	FL1 = FL - 30	-
24GS-101-00			1 Pcs / Adet	FL1 = FL - 33	-
24GS-104-00			2 Pcs / Adet	FH - 3	-
24GS-201-00			4 Pcs / Adet	SL = (FL-226)/4	-
24GS-202-00			4 Pcs / Adet	SL = (FL-226)/4	-
24GS-203-00			2 Pcs / Adet	FH - 51.5	-
24GS-213-00			2 Pcs / Adet	FH - 32	-
24GS-501-00			4 Pcs / Adet	FH - 51.5	-
24GS-204-00			1 Pcs / Adet	FH - 51.5	-
24GS-901-00			2 Pcs / Adet	FL - 30	-

**CONSUMABLE MATERIALS / SARF MALZEMELER**

Code Kod	Description Açıklama	Quantity (pcs-m) Miktar (Paket)	Picture Resim
EM24GS-104	FRAME CORNER CONNECTION PLASTIC SET KASA KÖŞE BİRLEŞİM PLASTİK TAKIMI	1 Set / Takım	
EM24GS-201	SASH CONNECTION PLASTIC SET KANAT BİRLEŞİM PLASTİK TAKIMI	2 Set / Takım	
EM24GS-501	CLAMP CONNECTION PLASTIC SET KENET BİRLEŞİM PLASTİK TAKIMI	4 Set / Takım	
EM24GS-213	FRAME ISOLATION PLASTIC SET KASA İZOLASYON PLASTİK TAKIMI	2 Set / Takım	
EM24GS-204	HEAD TO HEAD CONNECTION PLASTIC SET KAFA KAFA YA PLASTİK TAKIMI	1 Set / Takım	
EM09-0001	CAP / KAPAK	12 Pcs / Adet	

**GASKETS / FİTİLLER**

Code Kod	Picture Resim	Quantity Miktar
PB-48-350		10 (FH-50)
PB-67-500		8 SL
PB-67-600		2 FL + 4 (FH-50)
PB-67-800		8 SL
EM38SLS-05		2 FL

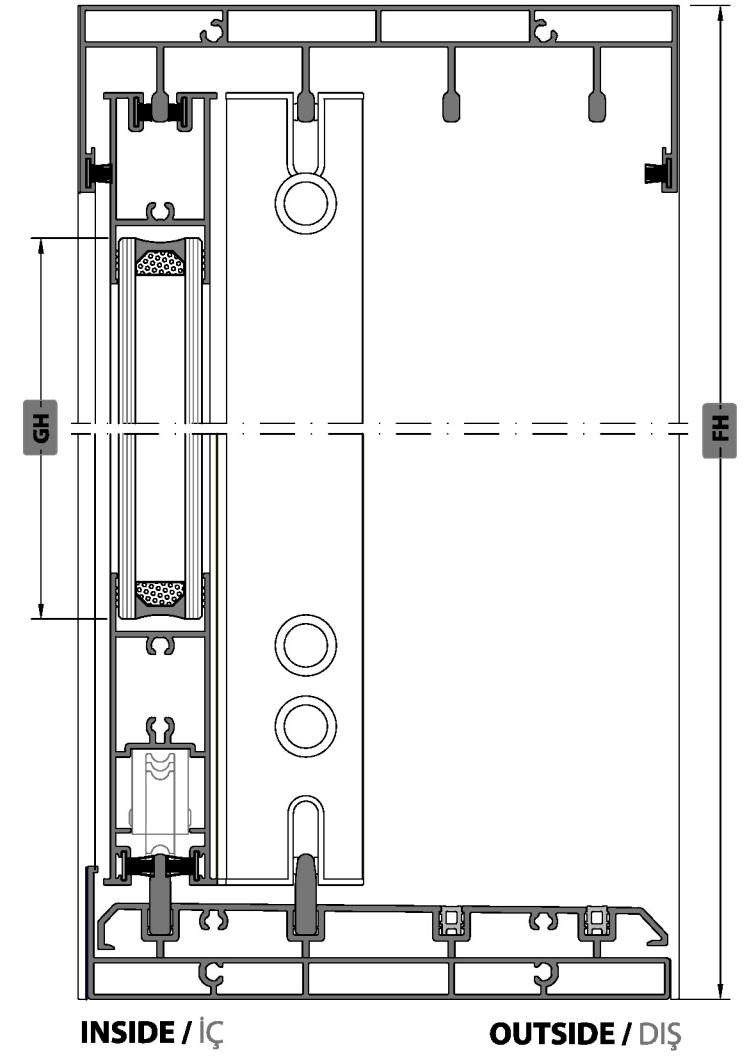

INSIDE / İÇ

OUTSIDE / DIŞ

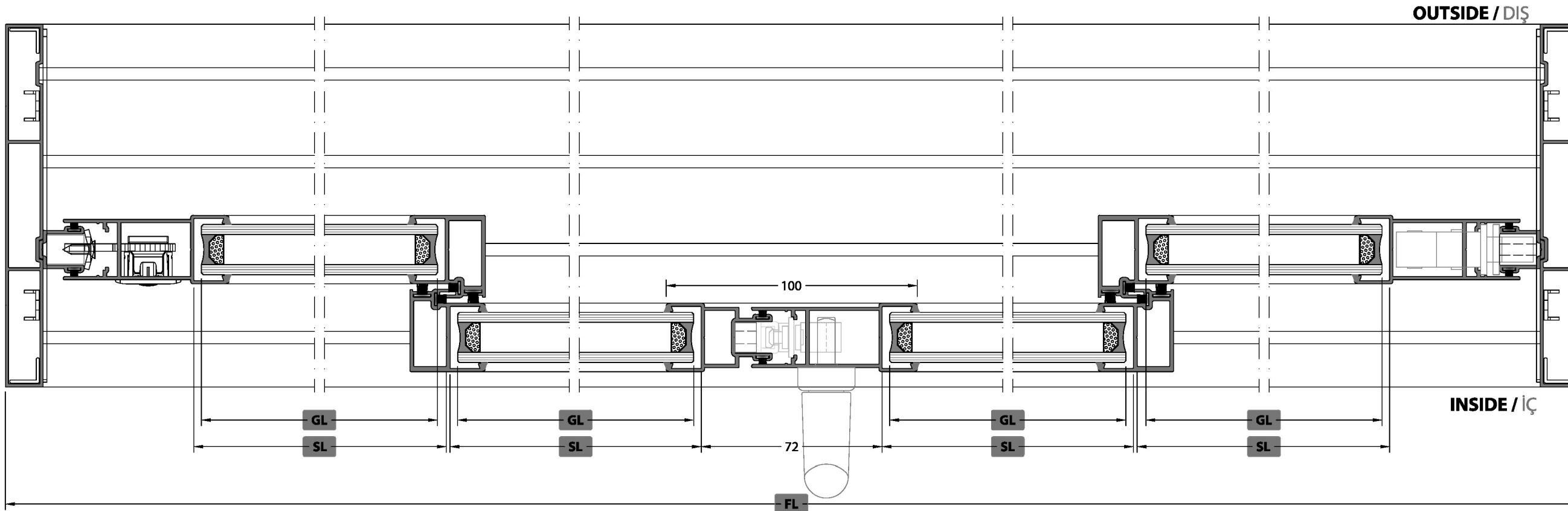

OUTSIDE / DIŞ

INSIDE / İÇ

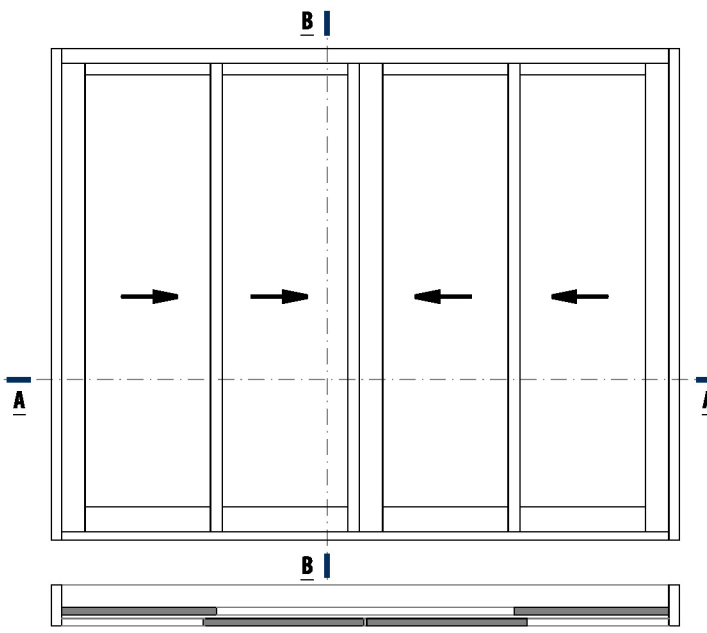

✓ Please look at the assembly drawings for mechanical treatment.  
Mekanik işlemler için lütfen uygulama detayları bölümüne bakınız.

**SASH GLASS / KANAT CAMI**

Code Kod	Drawing Çizim	Quantity Miktar	Dimensions (mm) Boyutlar
GLASS CAM		4 Pcs / Adet	GL = SL - 6 GH = FH - 138

**PROFILES / PROFİLLER**

Code Kod	Drawing Çizim	Cut Kesim	Quantity Miktar	Dimensions (mm) Boyutlar	Mechanical Treatment Mekanik İşlem
24GS-103-00			1 Pcs / Adet	FL1 = FL - 33	-
24GS-102-00			1 Pcs / Adet	FL1 = FL - 30	-
24GS-104-00			2 Pcs / Adet	FH - 1.5	-
24GS-201-00			4 Pcs / Adet	SL = (FL-226)/4	-
24GS-202-00			4 Pcs / Adet	SL = (FL-226)/4	-
24GS-203-00			2 Pcs / Adet	FH - 41.5	-
24GS-213-00			2 Pcs / Adet	FH - 22	-
24GS-501-00			4 Pcs / Adet	FH - 41.5	-
24GS-204-00			1 Pcs / Adet	FH - 41.5	-
24GS-901-00			2 Pcs / Adet	FL - 30	-

**CONSUMABLE MATERIALS / SARF MALZEMELER**

Code Kod	Description Açıklama	Quantity (pcs-m) Miktar (Paket)	Picture Resim
EM24GS-104	FRAME CORNER CONNECTION PLASTIC SET KASA KÖŞE BİRLEŞİM PLASTİK TAKIMI	1 Set / Takım	
EM24GS-201	SASH CONNECTION PLASTIC SET KANAT BİRLEŞİM PLASTİK TAKIMI	2 Set / Takım	
EM24GS-501	CLAMP CONNECTION PLASTIC SET KENET BİRLEŞİM PLASTİK TAKIMI	4 Set / Takım	
EM24GS-213	FRAME ISOLATION PLASTIC SET KASA İZOLASYON PLASTİK TAKIMI	2 Set / Takım	
EM24GS-204	HEAD TO HEAD CONNECTION PLASTIC SET KAFA KAFA YA PLASTİK TAKIMI	1 Set / Takım	
EM09-0001	CAP / KAPAK	12 Pcs / Adet	

**GASKETS / FİTİLLER**

Code Kod	Picture Resim	Quantity Miktar
PB-48-350		10 (FH-40)
PB-67-500		8 SL
PB-67-600		2 FL + 4 (FH-40)
PB-67-800		8 SL
EM38SLS-05		2 FL

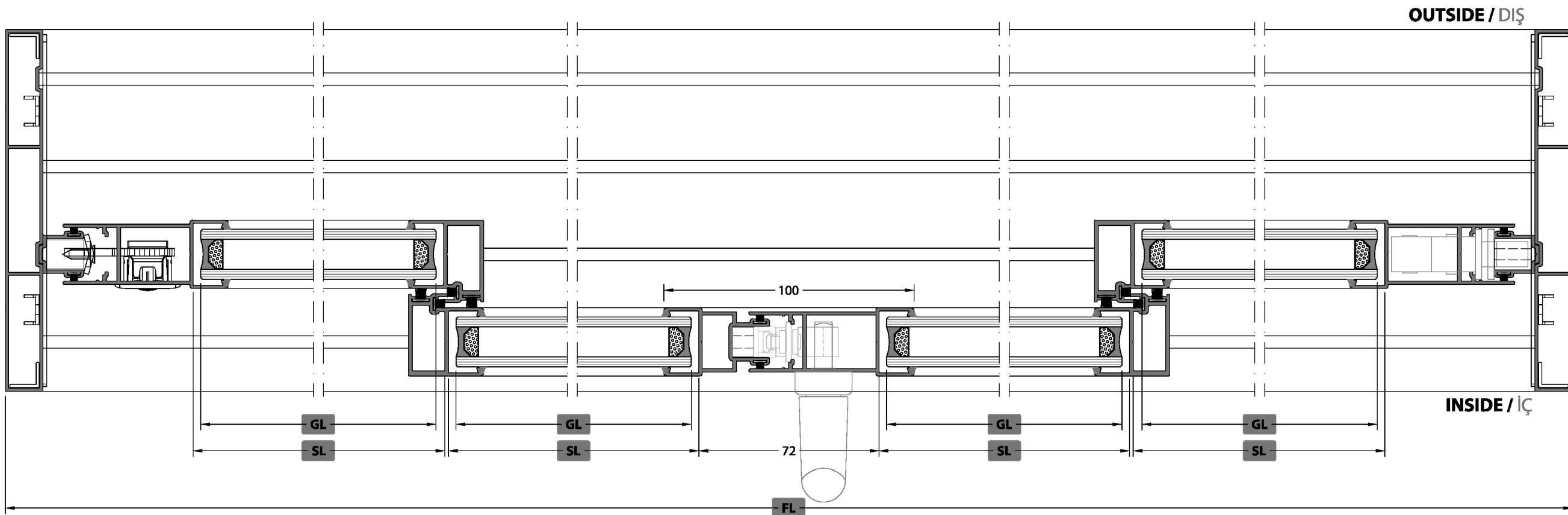
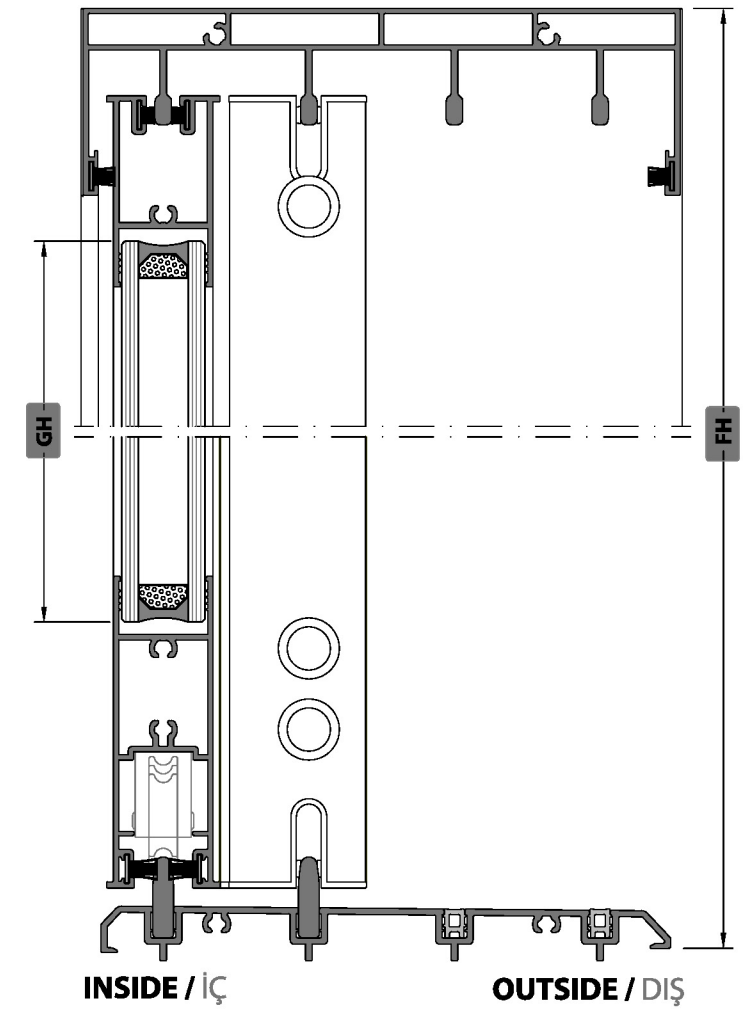

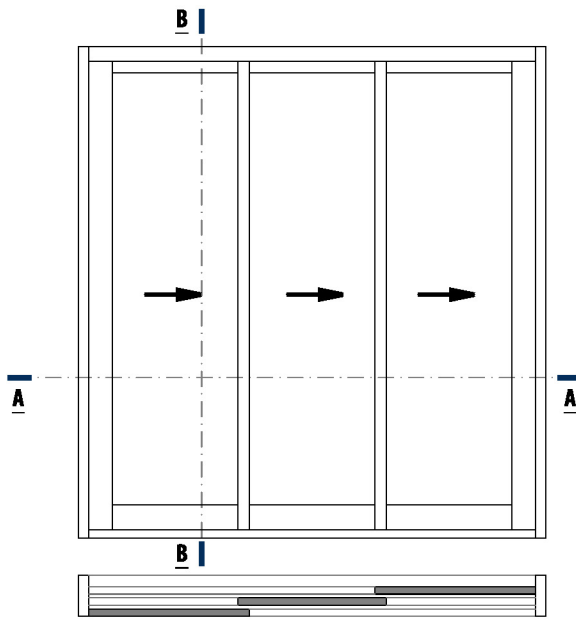

✓ Please look at the assembly drawings for mechanical treatment.  
Mekanik işlemler için lütfen uygulama detayları bölümüne bakınız.

**SASH GLASS / KANAT CAMI**

Code Kod	Drawing Çizim	Quantity Miktar	Dimensions (mm) Boyutlar
GLASS CAM		3 Pcs / Adet	GL = SL - 6 GH = FH - 148

**PROFILES / PROFİLLER**

Code Kod	Drawing Çizim	Cut Kesim	Quantity Miktar	Dimensions (mm) Boyutlar	Mechanical Treatment Mekanik İşlem
24GS-103-00			1 Pcs / Adet	FL1 = FL - 33	-
24GS-102-00			1 Pcs / Adet	FL - 30	-
24GS-101-00			1 Pcs / Adet	FL1 = FL - 33	-
24GS-104-00			2 Pcs / Adet	FH - 3	-
24GS-201-00			3 Pcs / Adet	SL = (FL-154)/3	-
24GS-202-00			3 Pcs / Adet	SL = (FL-154)/3	-
24GS-203-00			2 Pcs / Adet	FH - 51.5	-
24GS-213-00			2 Pcs / Adet	FH - 32	-
24GS-501-00			4 Pcs / Adet	FH - 51.5	-
24GS-901-00			3 Pcs / Adet	FL - 30	-

**CONSUMABLE MATERIALS / SARF MALZEMELER**

Code Kod	Description Açıklama	Quantity (pcs-m) Miktar (Paket)	Picture Resim
EM24GS-104	FRAME CORNER CONNECTION PLASTIC SET KASA KÖŞE BİRLEŞİM PLASTİK TAKIMI	1 Set / Takım	
EM24GS-201	SASH CONNECTION PLASTIC SET KANAT BİRLEŞİM PLASTİK TAKIMI	2 Set / Takım	
EM24GS-501	CLAMP CONNECTION PLASTIC SET KENET BİRLEŞİM PLASTİK TAKIMI	4 Set / Takım	
EM24GS-213	FRAME ISOLATION PLASTIC SET KASA İZOLASYON PLASTİK TAKIMI	2 Set / Takım	
EM09-0001	CAP / KAPAK	12 Pcs / Adet	

**GASKETS / FİTİLLER**

Code Kod	Picture Resim	Quantity Miktar
PB-48-350		8 (FH-50)
PB-67-500		6 SL
PB-67-600		2 FL + 4 (FH-50)
PB-67-800		6 SL
EM38SLS-05		1 FL

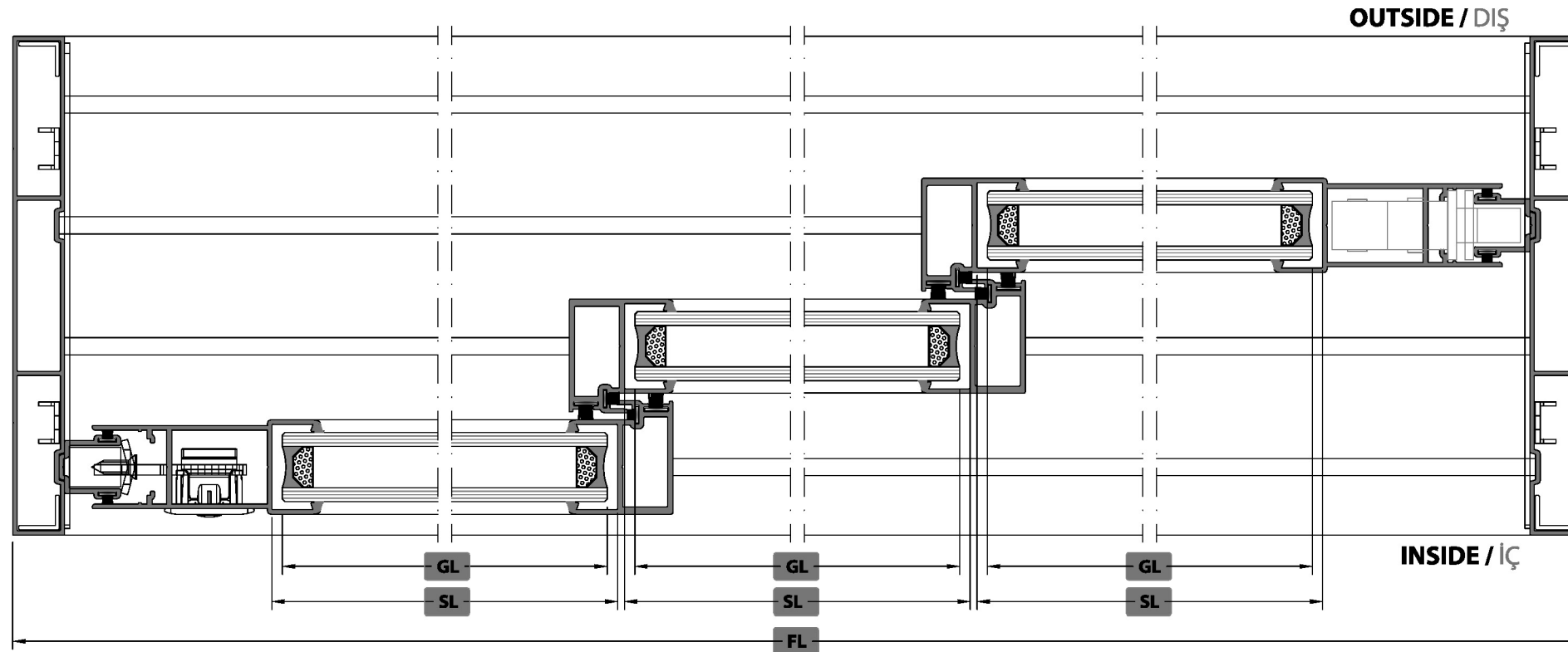
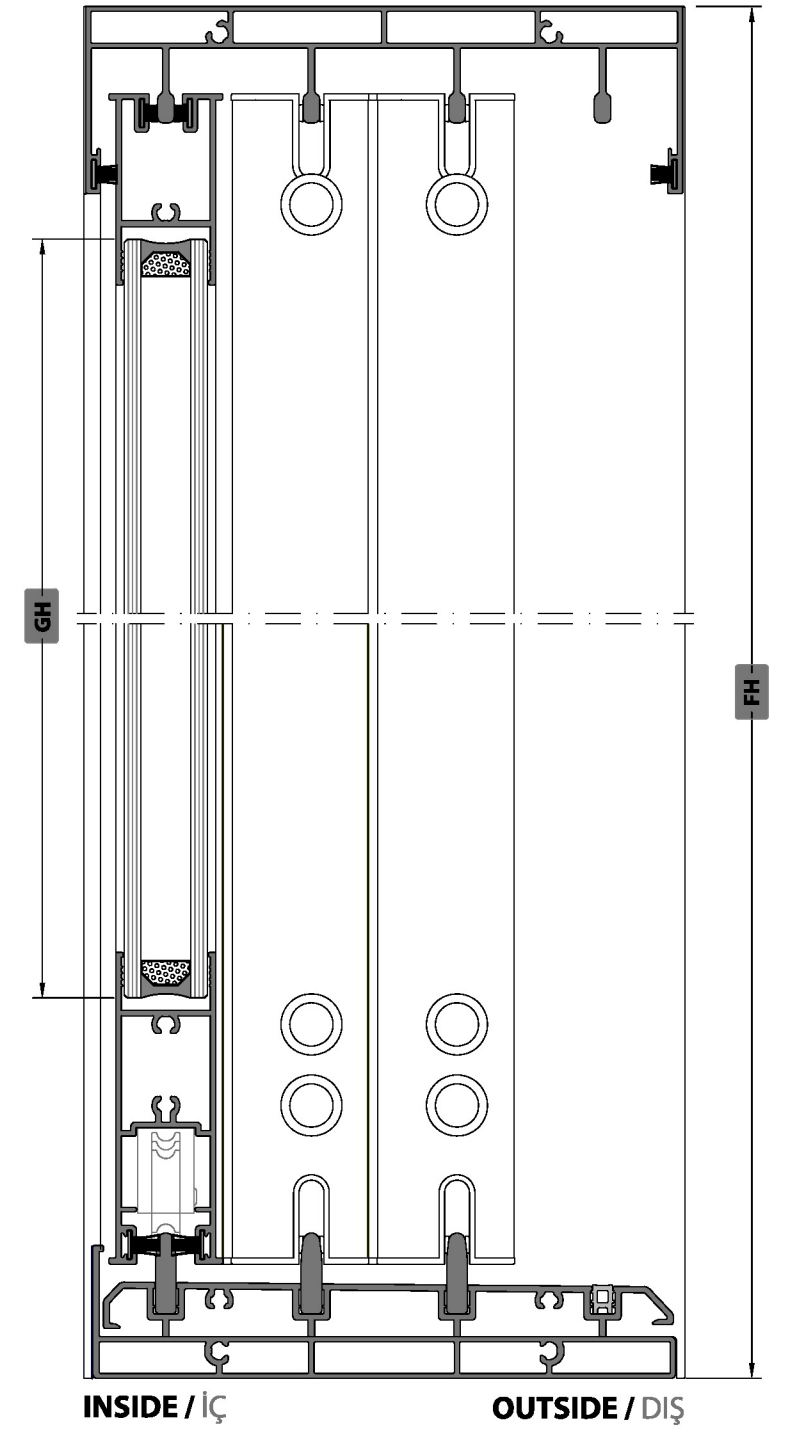

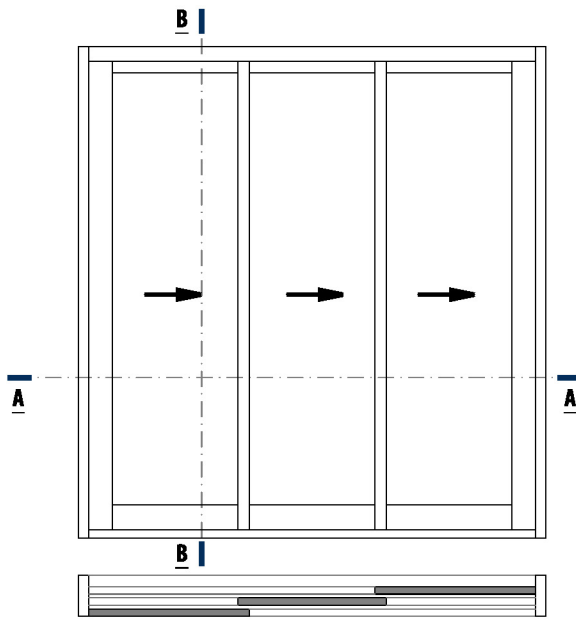

✓ Please look at the assembly drawings for mechanical treatment.  
Mekanik işlemler için lütfen uygulama detayları bölümüne bakınız.

**SASH GLASS / KANAT CAMI**

Code Kod	Drawing Çizim	Quantity Miktar	Dimensions (mm) Boyutlar
GLASS CAM		3 Pcs / Adet	GL = SL - 6 GH = FH - 138

**PROFILES / PROFİLLER**

Code Kod	Drawing Çizim	Cut Kesim	Quantity Miktar	Dimensions (mm) Boyutlar	Mechanical Treatment Mekanik İşlem
24GS-103-00			1 Pcs / Adet	FL1 = FL - 33	-
24GS-102-00			1 Pcs / Adet	FL1 = FL - 30	-
24GS-104-00			2 Pcs / Adet	FH - 1.5	-
24GS-201-00			3 Pcs / Adet	SL = (FL-154)/3	-
24GS-202-00			3 Pcs / Adet	SL = (FL-154)/3	-
24GS-203-00			2 Pcs / Adet	FH - 41.5	-
24GS-213-00			2 Pcs / Adet	FH - 22	-
24GS-501-00			4 Pcs / Adet	FH - 41.5	-
24GS-901-00			3 Pcs / Adet	FL - 30	-

**CONSUMABLE MATERIALS / SARF MALZEMELER**

Code Kod	Description Açıklama	Quantity (pcs-m) Miktar (Paket)	Picture Resim
EM24GS-104	FRAME CORNER CONNECTION PLASTIC SET KASA KÖŞE BİRLEŞİM PLASTİK TAKIMI	1 Set / Takım	
EM24GS-201	SASH CONNECTION PLASTIC SET KANAT BİRLEŞİM PLASTİK TAKIMI	2 Set / Takım	
EM24GS-501	CLAMP CONNECTION PLASTIC SET KENET BİRLEŞİM PLASTİK TAKIMI	4 Set / Takım	
EM24GS-213	FRAME ISOLATION PLASTIC SET KASA İZOLASYON PLASTİK TAKIMI	2 Set / Takım	
EM09-0001	CAP / KAPAK	12 Pcs / Adet	

**GASKETS / FİTİLLER**

Code Kod	Picture Resim	Quantity Miktar
PB-48-350		8 (FH-40)
PB-67-500		6 SL
PB-67-600		2 FL + 4 (FH-40)
PB-67-800		6 SL
EM38SLS-05		1 FL

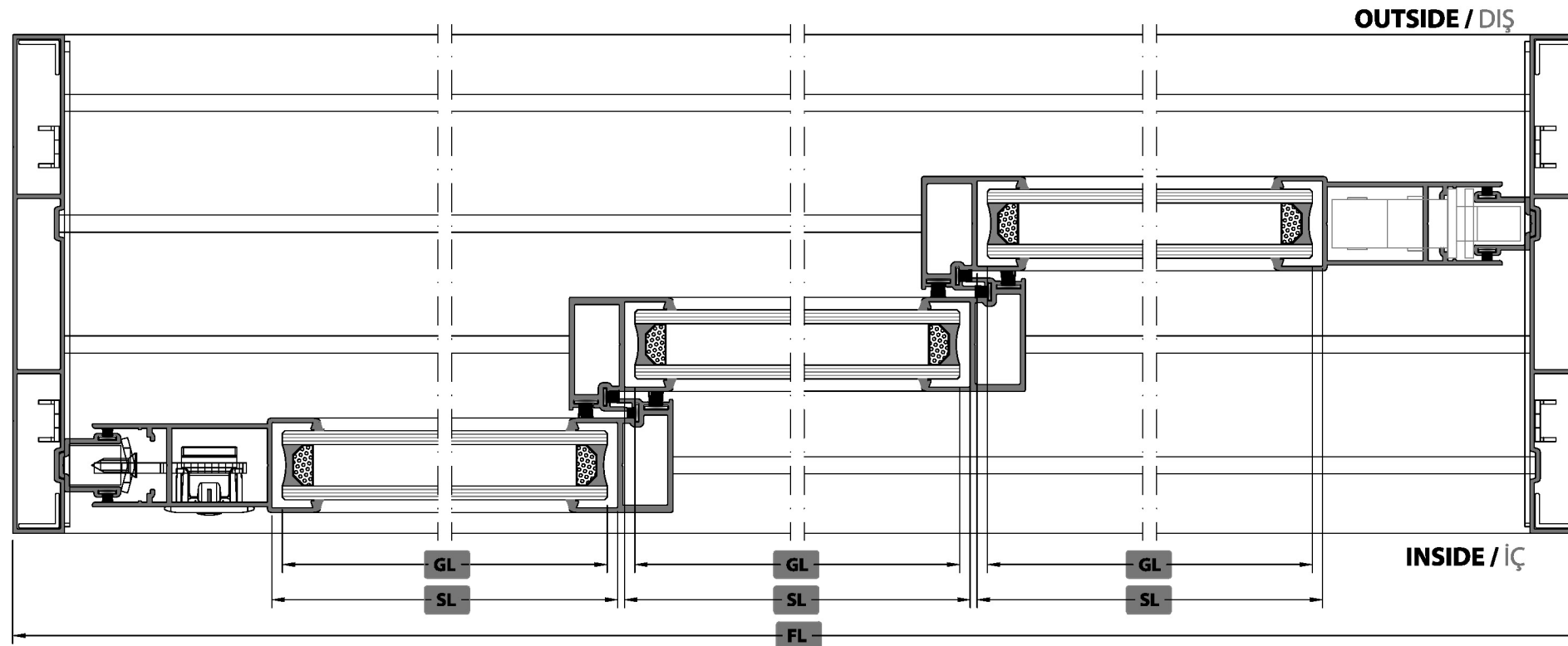
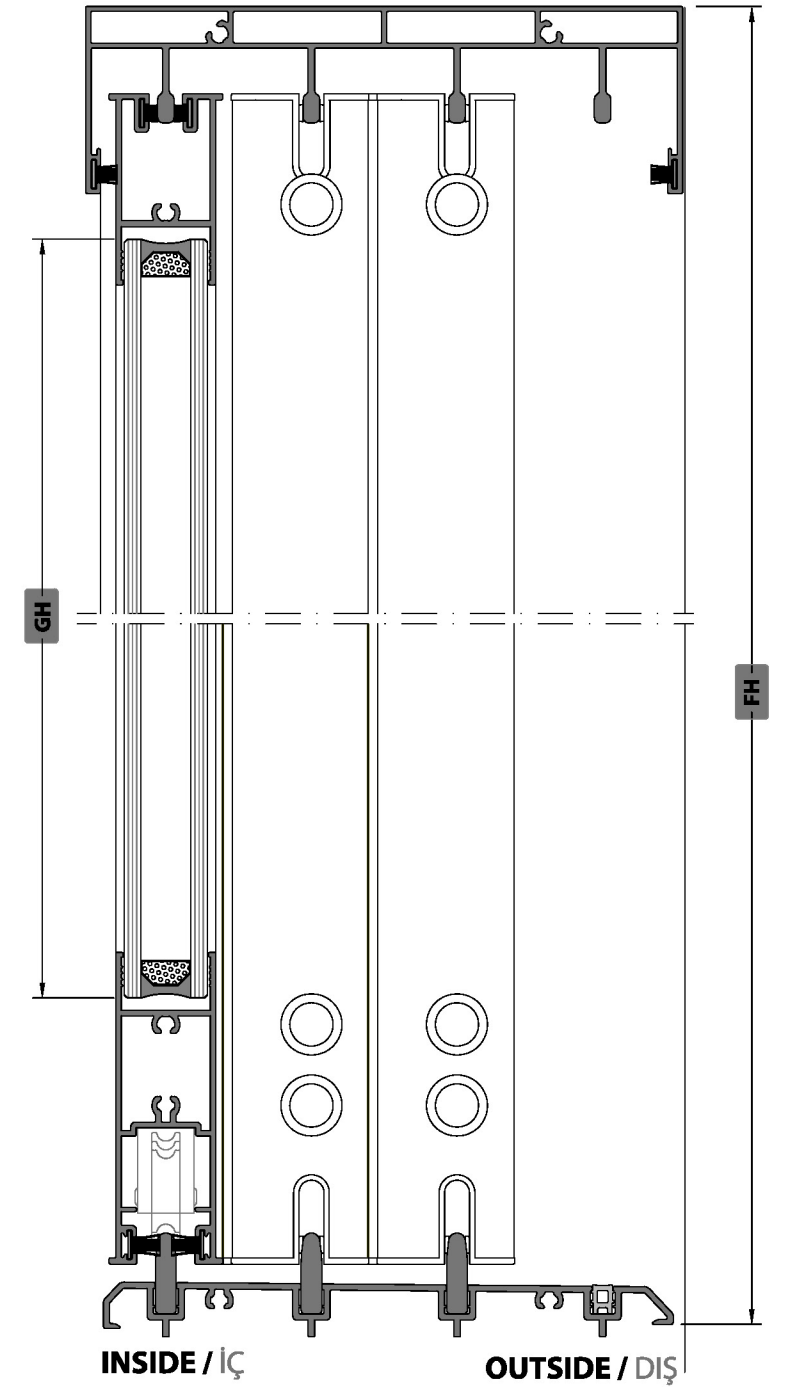

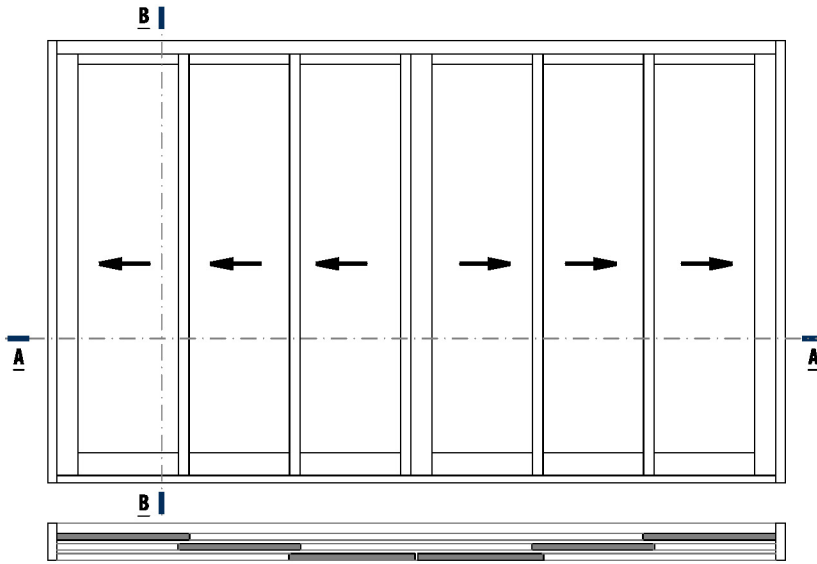

✓ Please look at the assembly drawings for mechanical treatment.  
Mekanik işlemler için lütfen uygulama detayları bölümüne bakınız.

SASH GLASS / KANAT CAMI

Code Kod	Drawing Çizim	Quantity Miktar	Dimensions (mm) Boyutlar
GLASS CAM		6 Pcs / Adet	GL = SL - 6 GH = FH - 148

PROFILES / PROFİLLER

Code Kod	Drawing Çizim	Cut Kesim	Quantity Miktar	Dimensions (mm) Boyutlar	Mechanical Treatment Mekanik İşlem
24GS-103-00			1 Pcs / Adet	FL1 = FL - 33	-
24GS-102-00			1 Pcs / Adet	FL1 = FL - 30	-
24GS-101-00			1 Pcs / Adet	FL1 = FL - 33	-
24GS-104-00			2 Pcs / Adet	FH - 3	-
24GS-201-00			6 Pcs / Adet	SL = (FL-230)/6	-
24GS-202-00			6 Pcs / Adet	SL = (FL-230)/6	-
24GS-203-00			2 Pcs / Adet	FH - 51.5	-
24GS-213-00			2 Pcs / Adet	FH - 32	-
24GS-501-00			8 Pcs / Adet	FH - 51.5	-
24GS-204-00			1 Pcs / Adet	FH - 51.5	-
24GS-901-00			3 Pcs / Adet	FL - 30	-

CONSUMABLE MATERIALS / SARF MALZEMELER

Code Kod	Description Açıklama	Quantity (pcs-m) Miktar (Paket)	Picture Resim
EM24GS-104	FRAME CORNER CONNECTION PLASTIC SET KASA KOŞE BİRLEŞİM PLASTİK TAKIMI	1 Set / Takım	
EM24GS-201	SASH CONNECTION PLASTIC SET KANAT BİRLEŞİM PLASTİK TAKIMI	2 Set / Takım	
EM24GS-501	CLAMP CONNECTION PLASTIC SET KENET BİRLEŞİM PLASTİK TAKIMI	8 Set / Takım	
EM24GS-213	FRAME ISOLATION PLASTIC SET KASA İZOLASYON PLASTİK TAKIMI	2 Set / Takım	
EM24GS-204	HEAD TO HEAD CONNECTION PLASTIC SET KAFA KAFAYA PLASTİK TAKIMI	1 Set / Takım	
EM09-0001	CAP / KAPAK	24 Pcs / Adet	

GASKETS / FİTİLLER

Code Kod	Picture Resim	Quantity Miktar
PB-48-350		14 (FH-50)
PB-67-500		12 SL
PB-67-600		2 FL + 8 (FH-50)
PB-67-800		12 SL
EM38SL5-05		1 FL

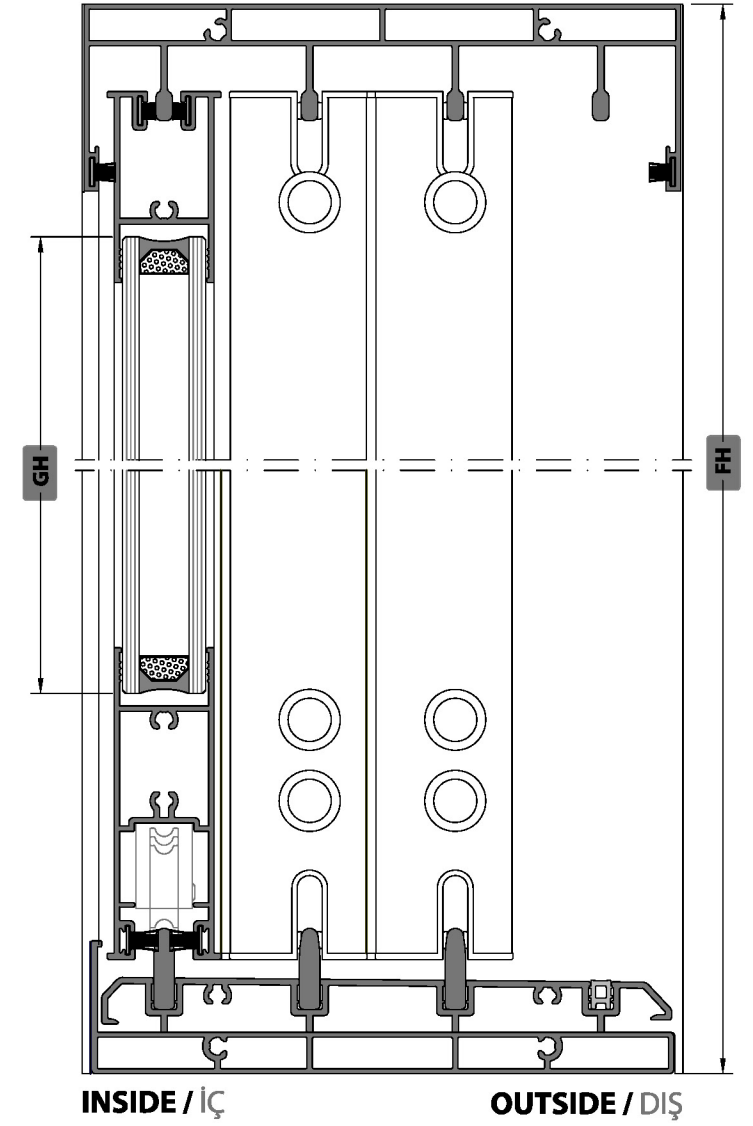

INSIDE / İÇ

OUTSIDE / DIŞ

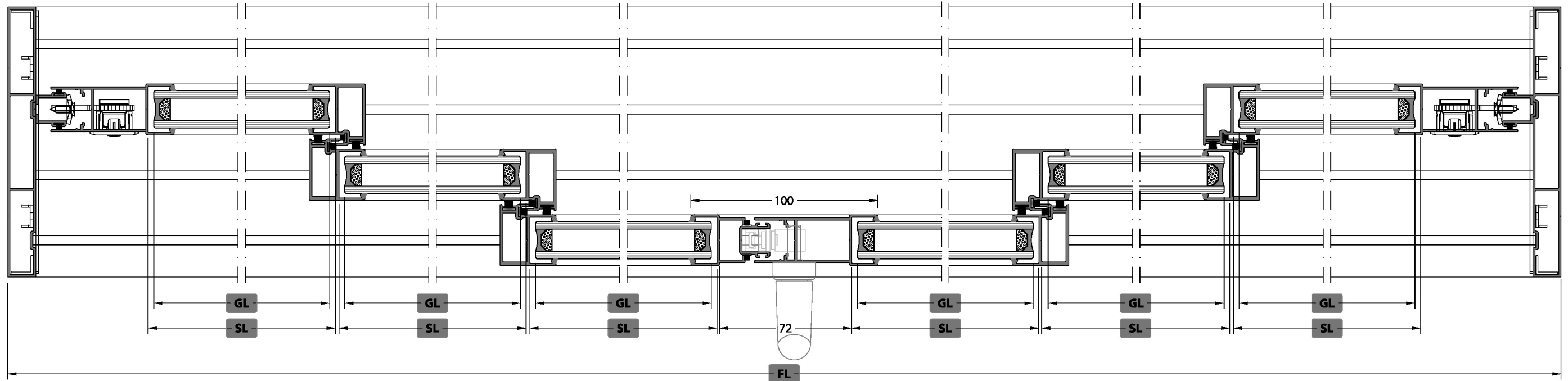

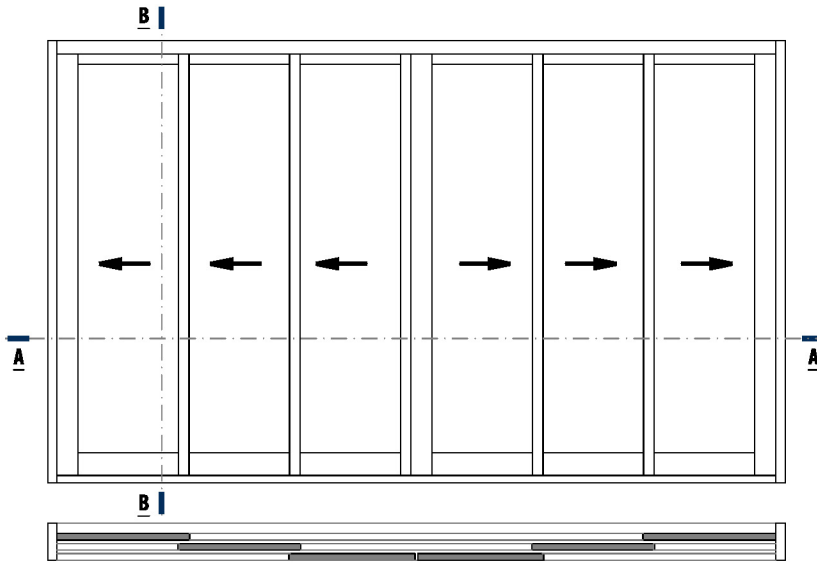

✓ Please look at the assembly drawings for mechanical treatment.  
Mekanik işlemler için lütfen uygulama detayları bölümüne bakınız.

SASH GLASS / KANAT CAMI

Code Kod	Drawing Çizim	Quantity Miktar	Dimensions (mm) Boyutlar
GLASS CAM		6 Pcs / Adet	GL = SL - 6 GH = FH - 138

PROFILES / PROFİLLER

Code Kod	Drawing Çizim	Cut Kesim	Quantity Miktar	Dimensions (mm) Boyutlar	Mechanical Treatment Mekanik İşlem
24GS-103-00			1 Pcs / Adet	FL1 = FL - 33	-
24GS-102-00			1 Pcs / Adet	FL1 = FL - 30	-
24GS-104-00			2 Pcs / Adet	FH - 1.5	-
24GS-201-00			6 Pcs / Adet	SL = (FL-230)/6	-
24GS-202-00			6 Pcs / Adet	SL = (FL-230)/6	-
24GS-203-00			2 Pcs / Adet	FH - 41.5	-
24GS-213-00			2 Pcs / Adet	FH - 22	-
24GS-501-00			8 Pcs / Adet	FH - 41.5	-
24GS-204-00			1 Pcs / Adet	FH - 41.5	-
24GS-901-00			3 Pcs / Adet	FL - 30	-

CONSUMABLE MATERIALS / SARF MALZEMELER

Code Kod	Description Açıklama	Quantity (pcs-m) Miktar (Paket)	Picture Resim
EM24GS-104	FRAME CORNER CONNECTION PLASTIC SET KASA KOŞE BİRLEŞİM PLASTİK TAKIMI	1 Set / Takım	
EM24GS-201	SASH CONNECTION PLASTIC SET KANAT BİRLEŞİM PLASTİK TAKIMI	2 Set / Takım	
EM24GS-501	CLAMP CONNECTION PLASTIC SET KENET BİRLEŞİM PLASTİK TAKIMI	8 Set / Takım	
EM24GS-213	FRAME ISOLATION PLASTIC SET KASA İZOLASYON PLASTİK TAKIMI	2 Set / Takım	
EM24GS-204	HEAD TO HEAD CONNECTION PLASTIC SET KAFA KAFA YA PLASTİK TAKIMI	1 Set / Takım	
EM09-0001	CAP / KAPAK	24 Pcs / Adet	

GASKETS / FİTİLLER

Code Kod	Picture Resim	Quantity Miktar
PB-48-350		14 (FH-40)
PB-67-500		12 SL
PB-67-600		2 FL + 8 (FH-40)
PB-67-800		12 SL
EM38SL5-05		1 FL

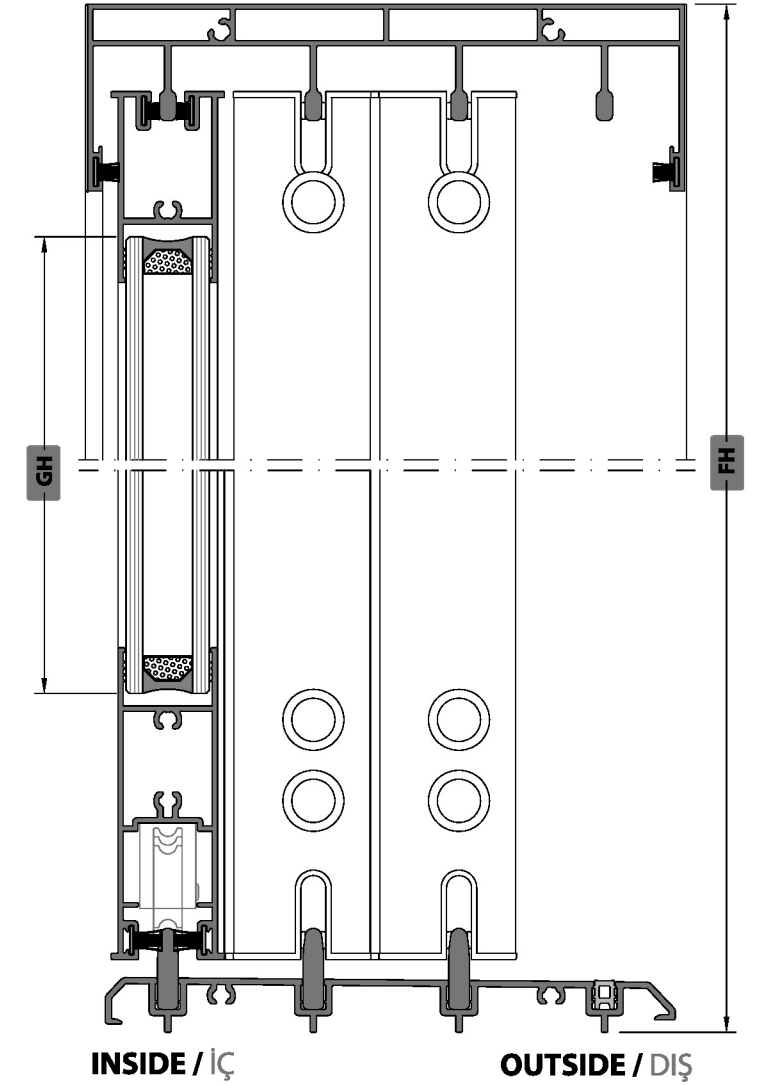

INSIDE / İÇ

OUTSIDE / DIŞ

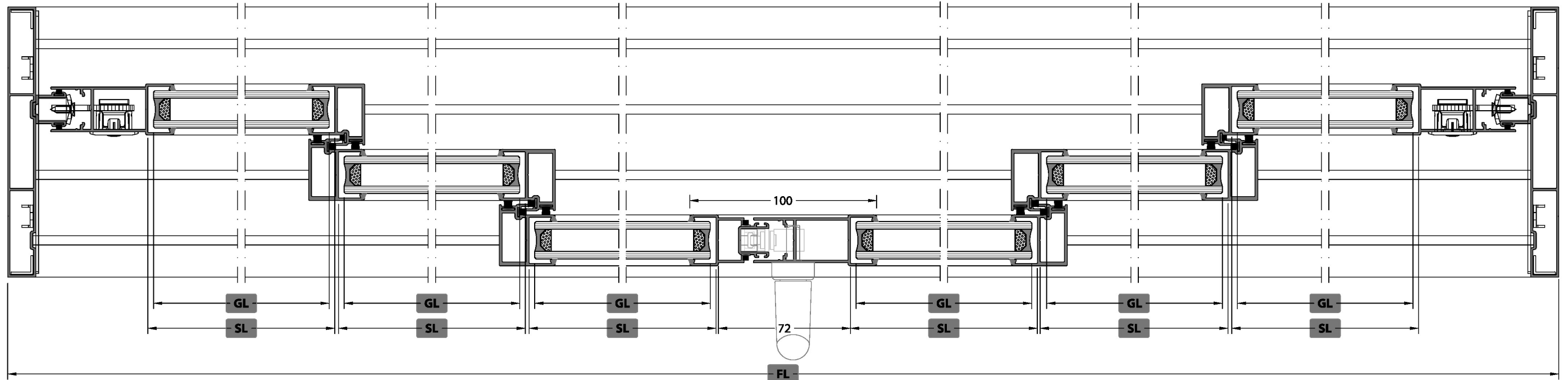

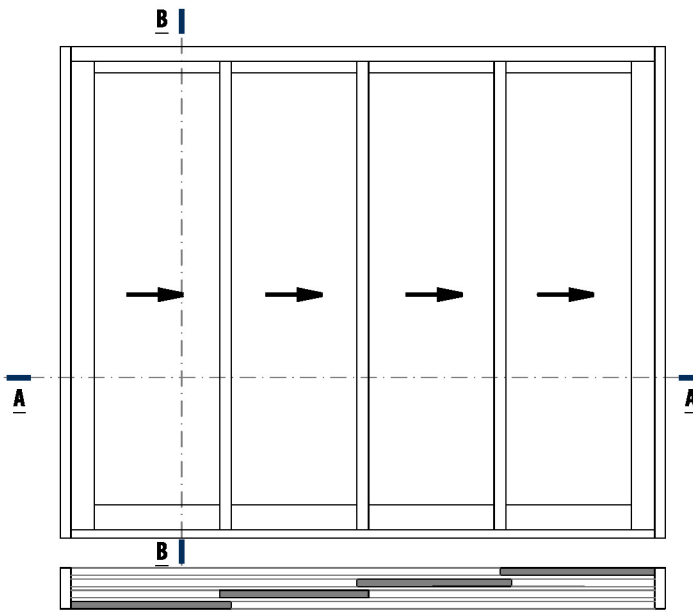

✓ Please look at the assembly drawings for mechanical treatment.  
Mekanik işlemler için lütfen uygulama detayları bölümüne bakınız.

SASH GLASS / KANAT CAMI

Code Kod	Drawing Çizim	Quantity Miktar	Dimensions (mm) Boyutlar
GLASS CAM		4 Pcs / Adet	GL = SL - 6 GH = FH - 148

PROFILES / PROFİLLER

Code Kod	Drawing Çizim	Cut Kesim	Quantity Miktar	Dimensions (mm) Boyutlar	Mechanical Treatment Mekanik İşlem
24GS-103-00			1 Pcs / Adet	FL1 = FL - 33	-
24GS-102-00			1 Pcs / Adet	FL1 = FL - 30	-
24GS-101-00			1 Pcs / Adet	FL1 = FL - 33	-
24GS-104-00			2 Pcs / Adet	FH - 3	-
24GS-201-00			4 Pcs / Adet	SL = (FL-156)/4	-
24GS-202-00			4 Pcs / Adet	SL = (FL-156)/4	-
24GS-203-00			2 Pcs / Adet	FH - 51.5	-
24GS-213-00			2 Pcs / Adet	FH - 32	-
24GS-501-00			6 Pcs / Adet	FH - 51.5	-
24GS-901-00			4 Pcs / Adet	FL - 30	-

CONSUMABLE MATERIALS / SARF MALZEMELER

Code Kod	Description Açıklama	Quantity (pcs-m) Miktar (Paket)	Picture Resim
EM24GS-104	FRAME CORNER CONNECTION PLASTIC SET KASA KÖŞE BİRLEŞİM PLASTİK TAKIMI	1 Set / Takım	
EM24GS-201	SASH CONNECTION PLASTIC SET KANAT BİRLEŞİM PLASTİK TAKIMI	2 Set / Takım	
EM24GS-501	CLAMP CONNECTION PLASTIC SET KENET BİRLEŞİM PLASTİK TAKIMI	6 Set / Takım	
EM24GS-213	FRAME ISOLATION PLASTIC SET KASA İZOLASYON PLASTİK TAKIMI	2 Set / Takım	
EM09-0001	CAP / KAPAK	18 Pcs / Adet	

GASKETS / FİTİLLER

Code Kod	Picture Resim	Quantity Miktar
PB-48-350		10 (FH-50)
PB-67-500		8 SL
PB-67-600		2 FL + 6 (FH-50)
PB-67-800		8 SL

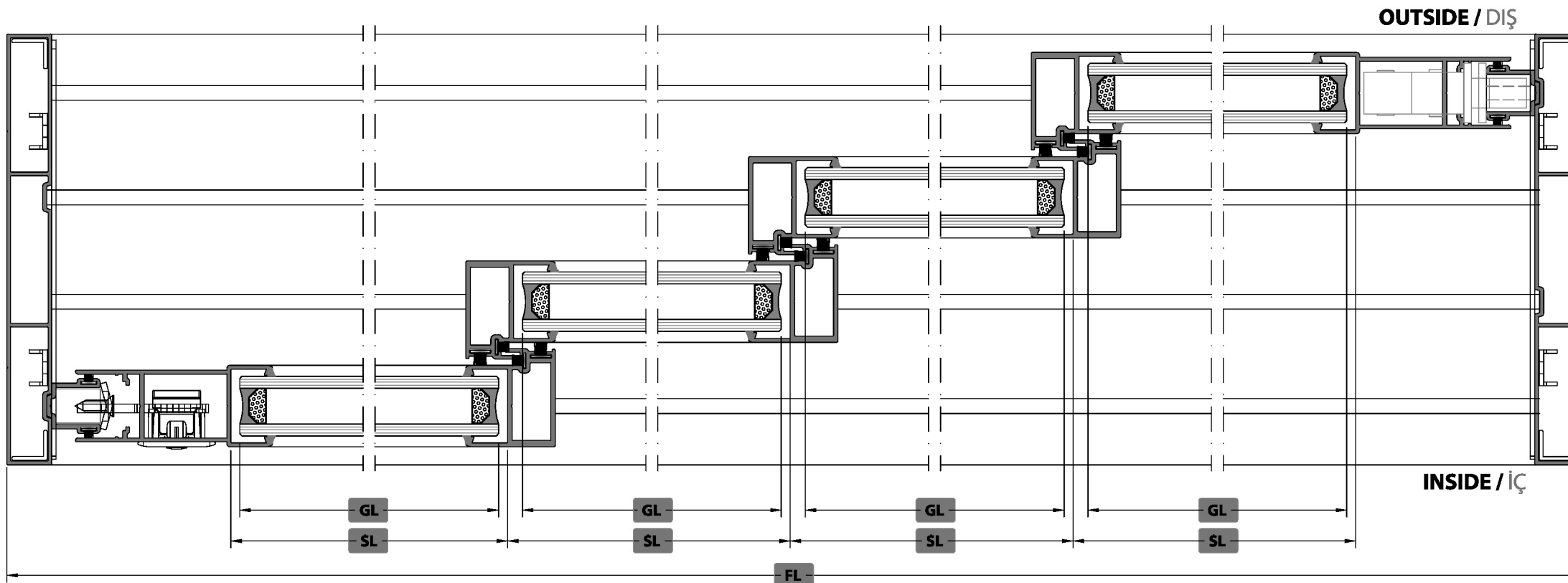
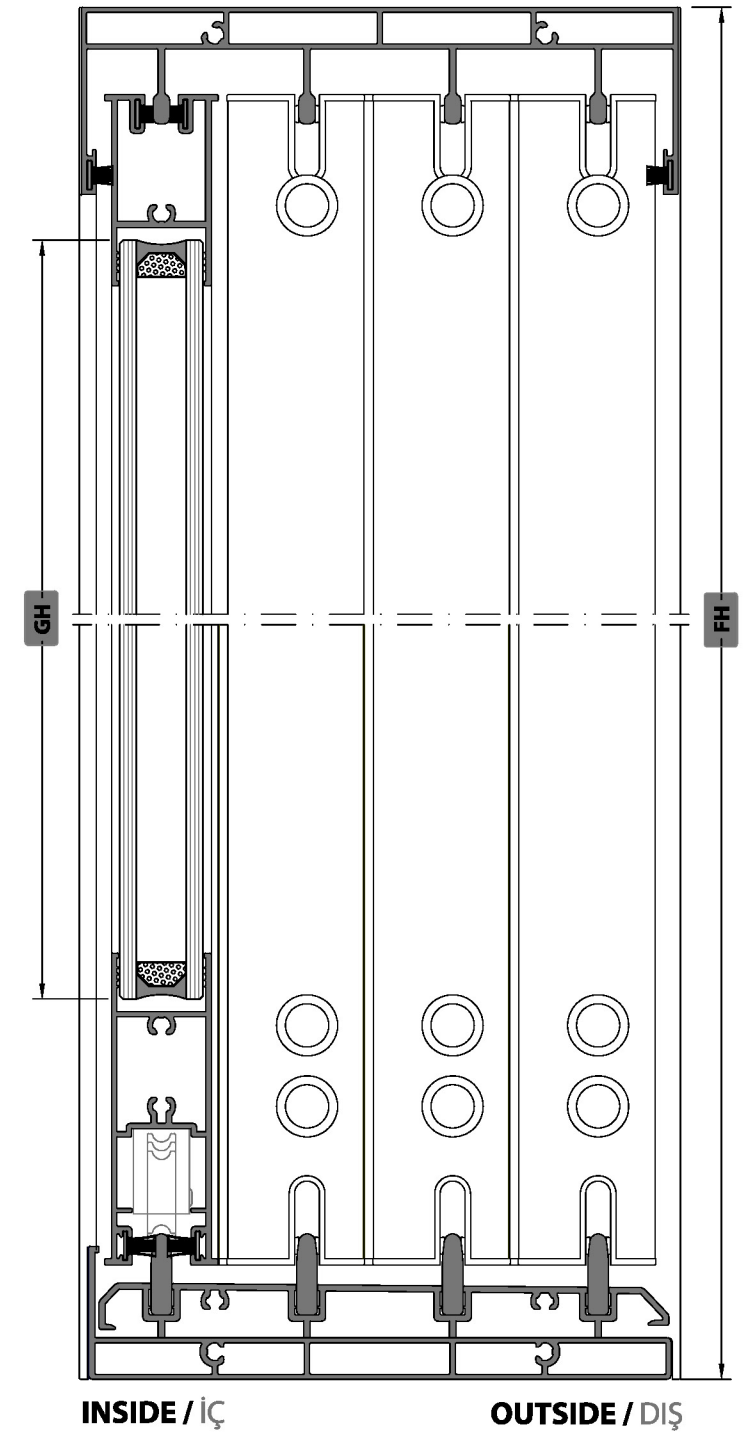

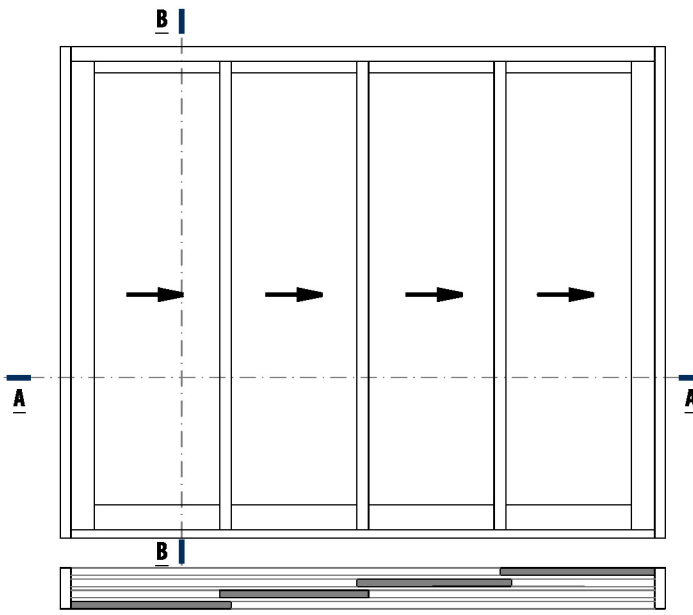

✓ Please look at the assembly drawings for mechanical treatment.  
Mekanik işlemler için lütfen uygulama detayları bölümüne bakınız.

SASH GLASS / KANAT CAMI

Code Kod	Drawing Çizim	Quantity Miktar	Dimensions (mm) Boyutlar
GLASS CAM		4 Pcs / Adet	GL = SL - 6 GH = FH - 138

PROFILES / PROFİLLER

Code Kod	Drawing Çizim	Cut Kesim	Quantity Miktar	Dimensions (mm) Boyutlar	Mechanical Treatment Mekanik İşlem
24GS-103-00			1 Pcs / Adet	FL1 = FL - 33	-
24GS-102-00			1 Pcs / Adet	FL1 = FL - 30	-
24GS-104-00			2 Pcs / Adet	FH - 1.5	-
24GS-201-00			4 Pcs / Adet	SL = (FL-156)/4	-
24GS-202-00			4 Pcs / Adet	SL = (FL-156)/4	-
24GS-203-00			2 Pcs / Adet	FH - 41.5	-
24GS-213-00			2 Pcs / Adet	FH - 22	-
24GS-501-00			6 Pcs / Adet	FH - 41.5	-
24GS-901-00			4 Pcs / Adet	FL - 30	-

CONSUMABLE MATERIALS / SARF MALZEMELER

Code Kod	Description Açıklama	Quantity (pcs-m) Miktar (Paket)	Picture Resim
EM24GS-104	FRAME CORNER CONNECTION PLASTIC SET KASA KÖŞE BİRLEŞİM PLASTİK TAKIMI	1 Set / Takım	
EM24GS-201	SASH CONNECTION PLASTIC SET KANAT BİRLEŞİM PLASTİK TAKIMI	2 Set / Takım	
EM24GS-501	CLAMP CONNECTION PLASTIC SET KENET BİRLEŞİM PLASTİK TAKIMI	6 Set / Takım	
EM24GS-213	FRAME ISOLATION PLASTIC SET KASA İZOLASYON PLASTİK TAKIMI	2 Set / Takım	
EM09-0001	CAP / KAPAK	18 Pcs / Adet	

GASKETS / FİTİLLER

Code Kod	Picture Resim	Quantity Miktar
PB-48-350		10 (FH-40)
PB-67-500		8 SL
PB-67-600		2 FL + 6 (FH-40)
PB-67-800		8 SL

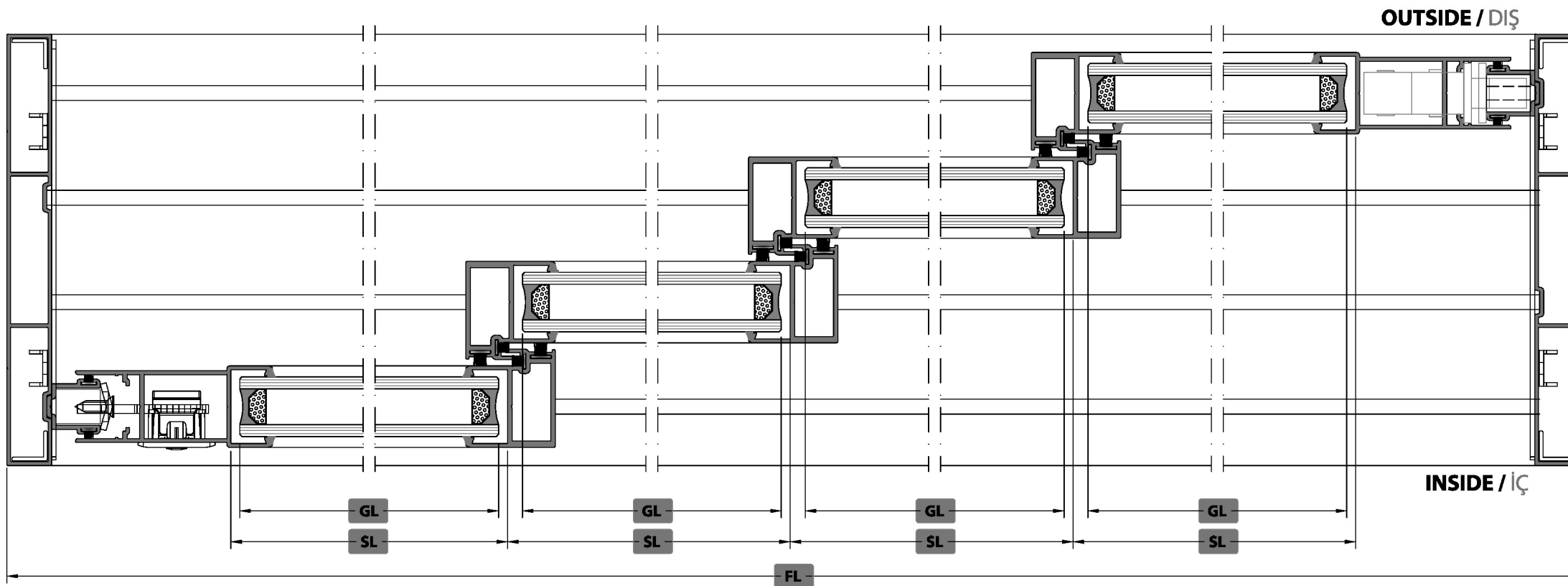
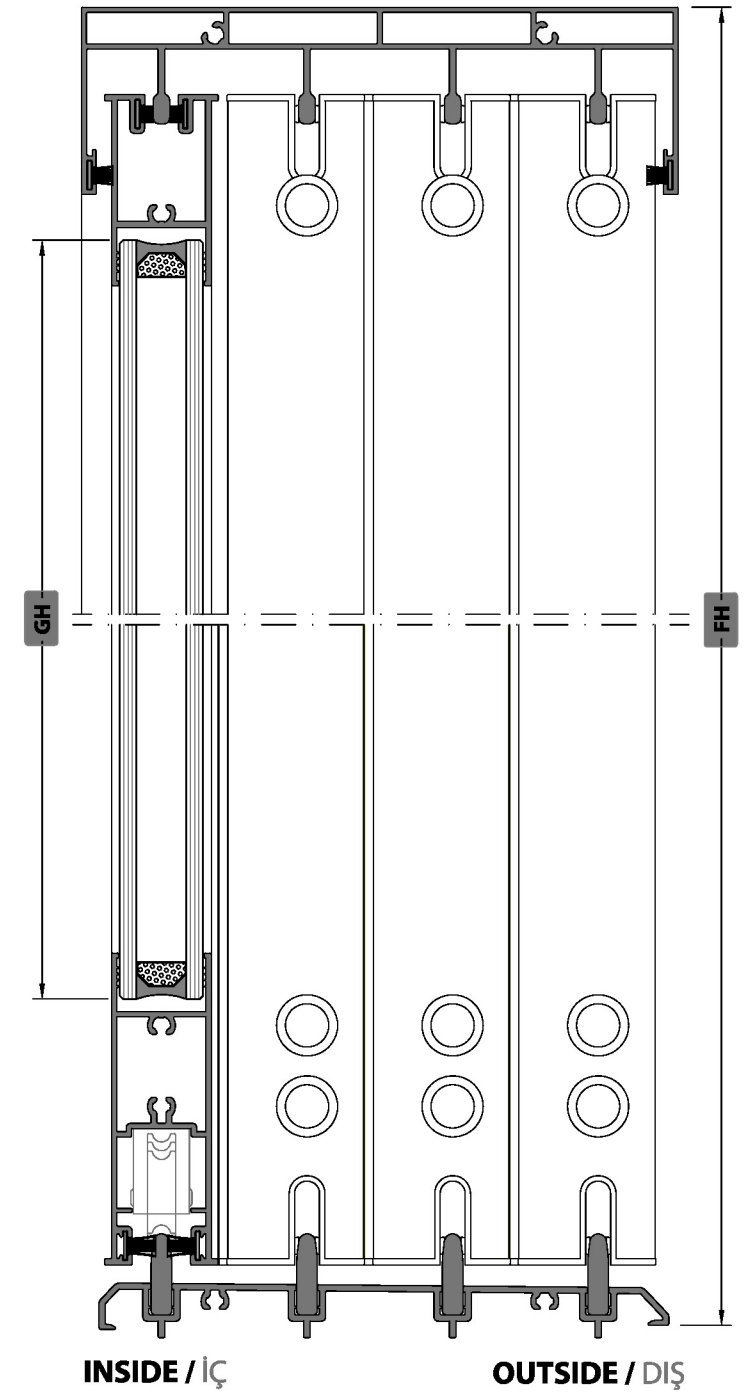

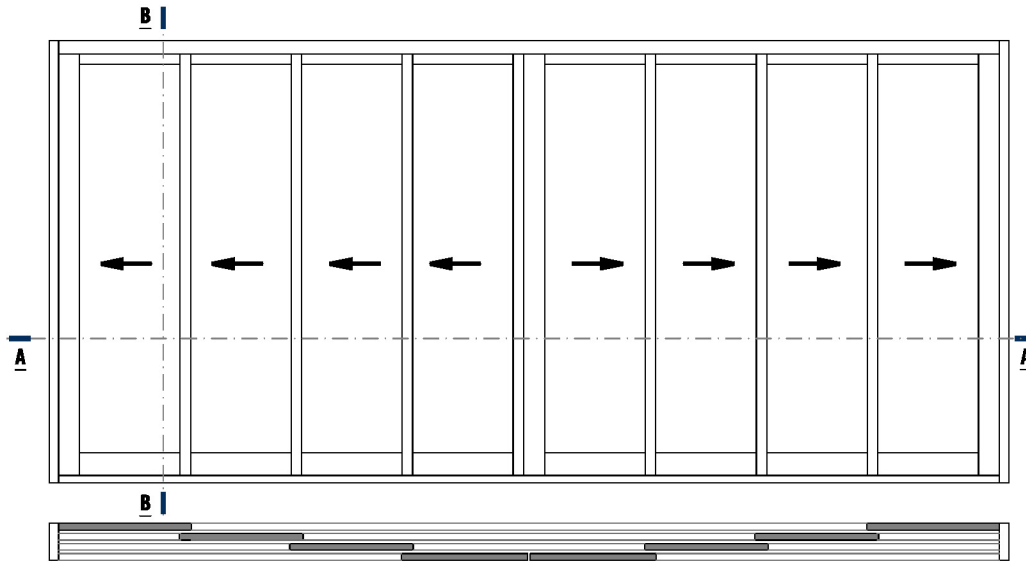

✓ Please look at the assembly drawings for mechanical treatment.  
Mekanik işlemler için lütfen uygulama detayları bölümüne bakınız.

SASH GLASS / KANAT CAMI

Code Kod	Drawing Çizim	Quantity Miktar	Dimensions (mm) Boyutlar
GLASS CAM		8 Pcs / Adet	GL = SL - 6 GH = FH - 148

PROFILES / PROFİLLER

Code Kod	Drawing Çizim	Cut Kesim	Quantity Miktar	Dimensions (mm) Boyutlar	Mechanical Treatment Mekanik İşlem
24GS-103-00			1 Pcs / Adet	FL1 = FL - 33	-
24GS-102-00			1 Pcs / Adet	FL1 = FL - 30	-
24GS-101-00			1 Pcs / Adet	FL1 = FL - 33	-
24GS-104-00			2 Pcs / Adet	FH - 3	-
24GS-201-00			8 Pcs / Adet	SL = (FL-234)/8	-
24GS-202-00			8 Pcs / Adet	SL = (FL-234)/8	-
24GS-203-00			2 Pcs / Adet	FH - 51.5	-
24GS-213-00			2 Pcs / Adet	FH - 32	-
24GS-501-00			12 Pcs / Adet	FH - 51.5	-
24GS-204-00			1 Pcs / Adet	FH - 51.5	-
24GS-901-00			4 Pcs / Adet	FL - 30	-

CONSUMABLE MATERIALS / SARF MALZEMELER

Code Kod	Description Açıklama	Quantity (pcs-m) Miktar (Paket)	Picture Resim
EM24GS-104	FRAME CORNER CONNECTION PLASTIC SET KASA KOŞE BİRLEŞİM PLASTİK TAKIMI	1 Set / Takım	
EM24GS-201	SASH CONNECTION PLASTIC SET KANAT BİRLEŞİM PLASTİK TAKIMI	2 Set / Takım	
EM24GS-501	CLAMP CONNECTION PLASTIC SET KENET BİRLEŞİM PLASTİK TAKIMI	12 Set / Takım	
EM24GS-213	FRAME ISOLATION PLASTIC SET KASA İZOLASYON PLASTİK TAKIMI	2 Set / Takım	
EM24GS-204	HEAD TO HEAD CONNECTION PLASTIC SET KAFA KAFA YA PLASTİK TAKIMI	1 Set / Takım	
EM09-0001	CAP / KAPAK	36 Pcs / Adet	

GASKETS / FİTİLLER

Code Kod	Picture Resim	Quantity Miktar
PB-48-350		18 (FH-50)
PB-67-500		16 SL
PB-67-600		2 FL + 12 (FH-50)
PB-67-800		16 SL

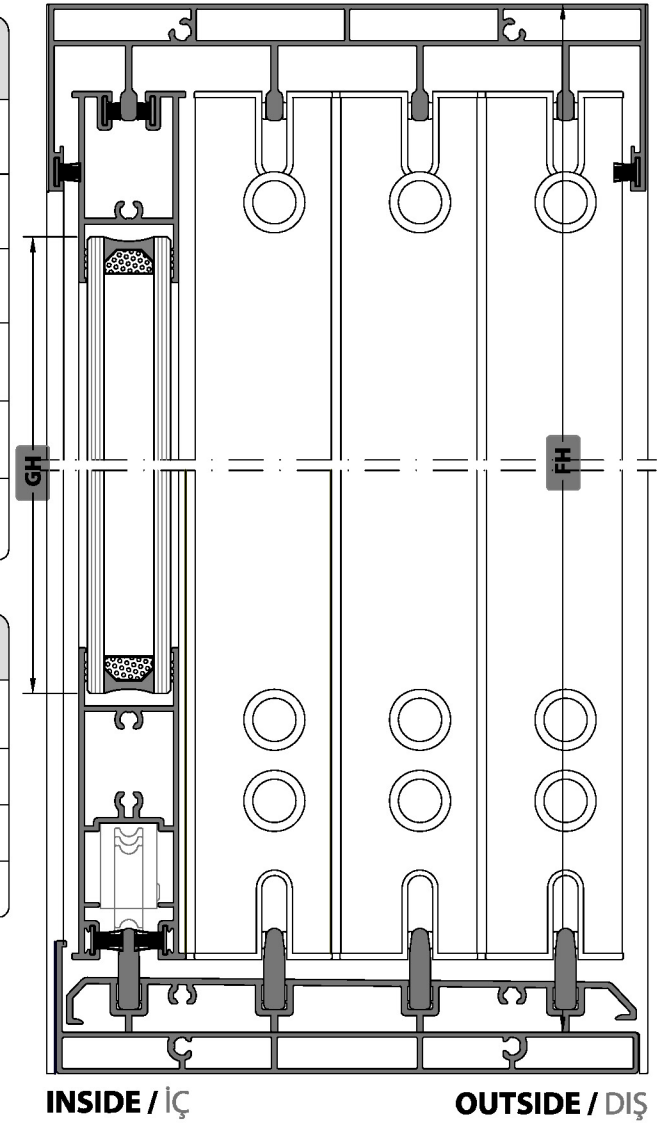

INSIDE / İÇ

OUTSIDE / DIŞ

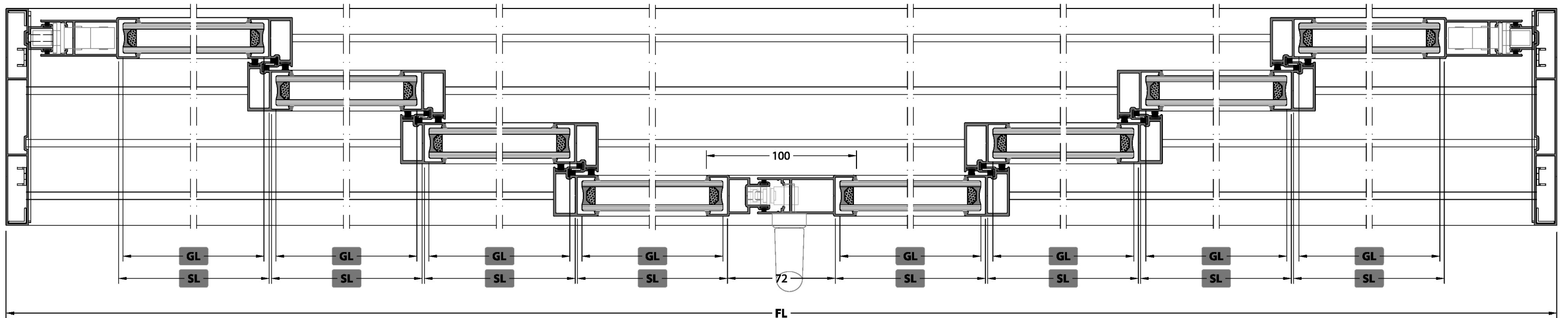

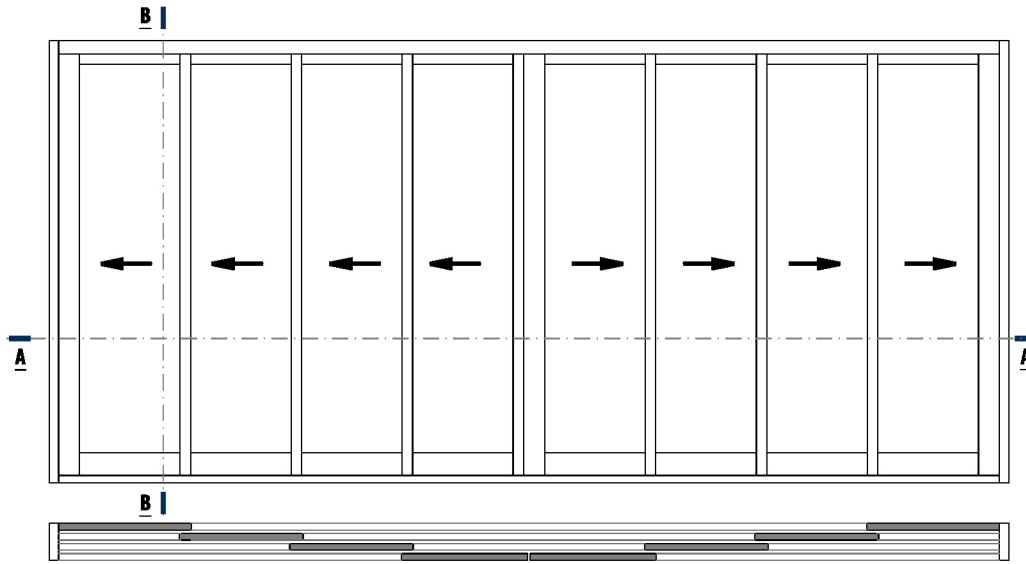

✓ Please look at the assembly drawings for mechanical treatment.  
Mekanik işlemler için lütfen uygulama detayları bölümüne bakınız.

**SASH GLASS / KANAT CAMI**

Code Kod	Drawing Çizim	Quantity Miktar	Dimensions (mm) Boyutlar
<b>GLASS CAM</b>		8 Pcs / Adet	GL = SL - 6 GH = FH - 148

**PROFILES / PROFİLLER**

Code Kod	Drawing Çizim	Cut Kesim	Quantity Miktar	Dimensions (mm) Boyutlar	Mechanical Treatment Mekanik İşlem
<b>24GS-103-00</b>			1 Pcs / Adet	FL1 = FL - 33	-
<b>24GS-102-00</b>			1 Pcs / Adet	FL1 = FL - 30	-
<b>24GS-104-00</b>			2 Pcs / Adet	FH - 1.5	-
<b>24GS-201-00</b>			8 Pcs / Adet	SL = (FL-234)/8	-
<b>24GS-202-00</b>			8 Pcs / Adet	SL = (FL-234)/8	-
<b>24GS-203-00</b>			2 Pcs / Adet	FH - 41.5	-
<b>24GS-213-00</b>			2 Pcs / Adet	FH - 22	-
<b>24GS-501-00</b>			12 Pcs / Adet	FH - 41.5	-
<b>24GS-204-00</b>			1 Pcs / Adet	FH - 41.5	-
<b>24GS-901-00</b>			4 Pcs / Adet	FL - 30	-

**CONSUMABLE MATERIALS / SARF MALZEMELER**

Code Kod	Description Açıklama	Quantity (pcs-m) Miktar (Paket)	Picture Resim
<b>EM24GS-104</b>	<b>FRAME CORNER CONNECTION PLASTIC SET</b> KASA KOŞE BİRLEŞİM PLASTİK TAKIMI	1 Set / Takım	
<b>EM24GS-201</b>	<b>SASH CONNECTION PLASTIC SET</b> KANAT BİRLEŞİM PLASTİK TAKIMI	2 Set / Takım	
<b>EM24GS-501</b>	<b>CLAMP CONNECTION PLASTIC SET</b> KENET BİRLEŞİM PLASTİK TAKIMI	12 Set / Takım	
<b>EM24GS-213</b>	<b>FRAME ISOLATION PLASTIC SET</b> KASA İZOLASYON PLASTİK TAKIMI	2 Set / Takım	
<b>EM24GS-204</b>	<b>HEAD TO HEAD CONNECTION PLASTIC SET</b> KAFA KAFAYA PLASTİK TAKIMI	1 Set / Takım	
<b>EM09-0001</b>	<b>CAP / KAPAK</b>	36 Pcs / Adet	

**GASKETS / FİTİLLER**

Code Kod	Picture Resim	Quantity Miktar
<b>PB-48-350</b>		18 (FH-40)
<b>PB-67-500</b>		16 SL
<b>PB-67-600</b>		2 FL + 12 (FH-40)
<b>PB-67-800</b>		16 SL

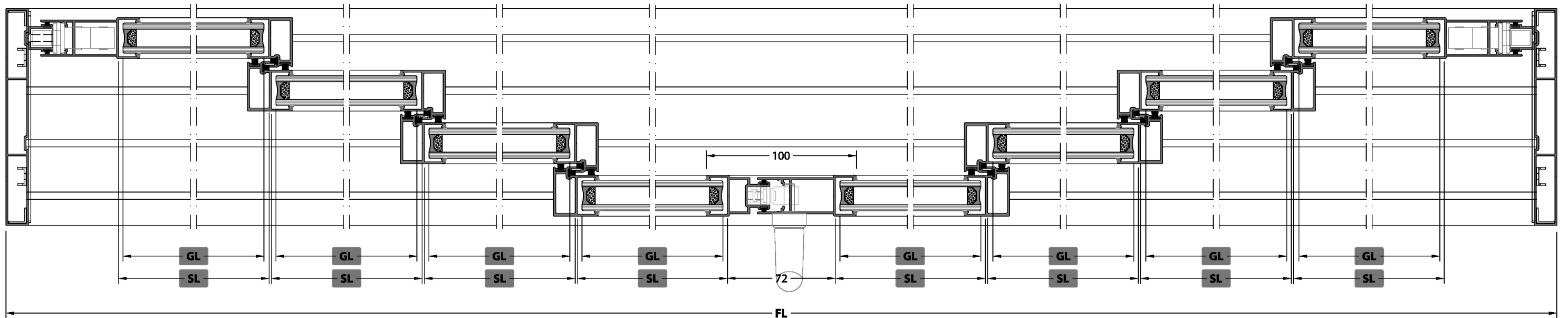
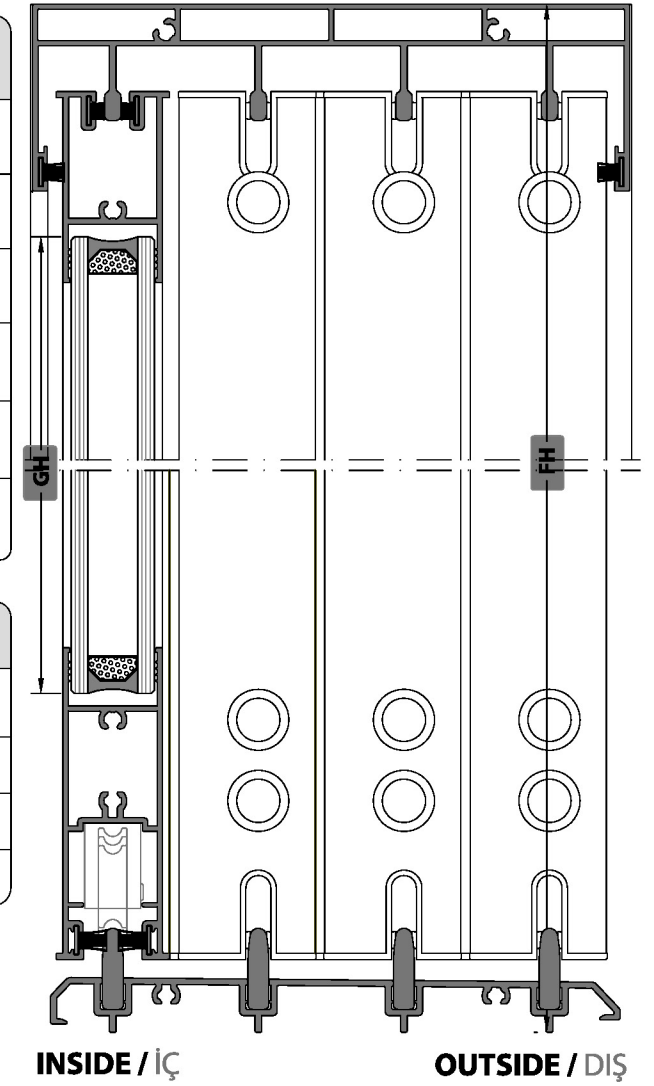

ASSEMBLY DETAILS  
MONTAJ DETAYLARI

WITH BOTTOM FRAME APPLICATION / ALT KASALI UYGULAMA

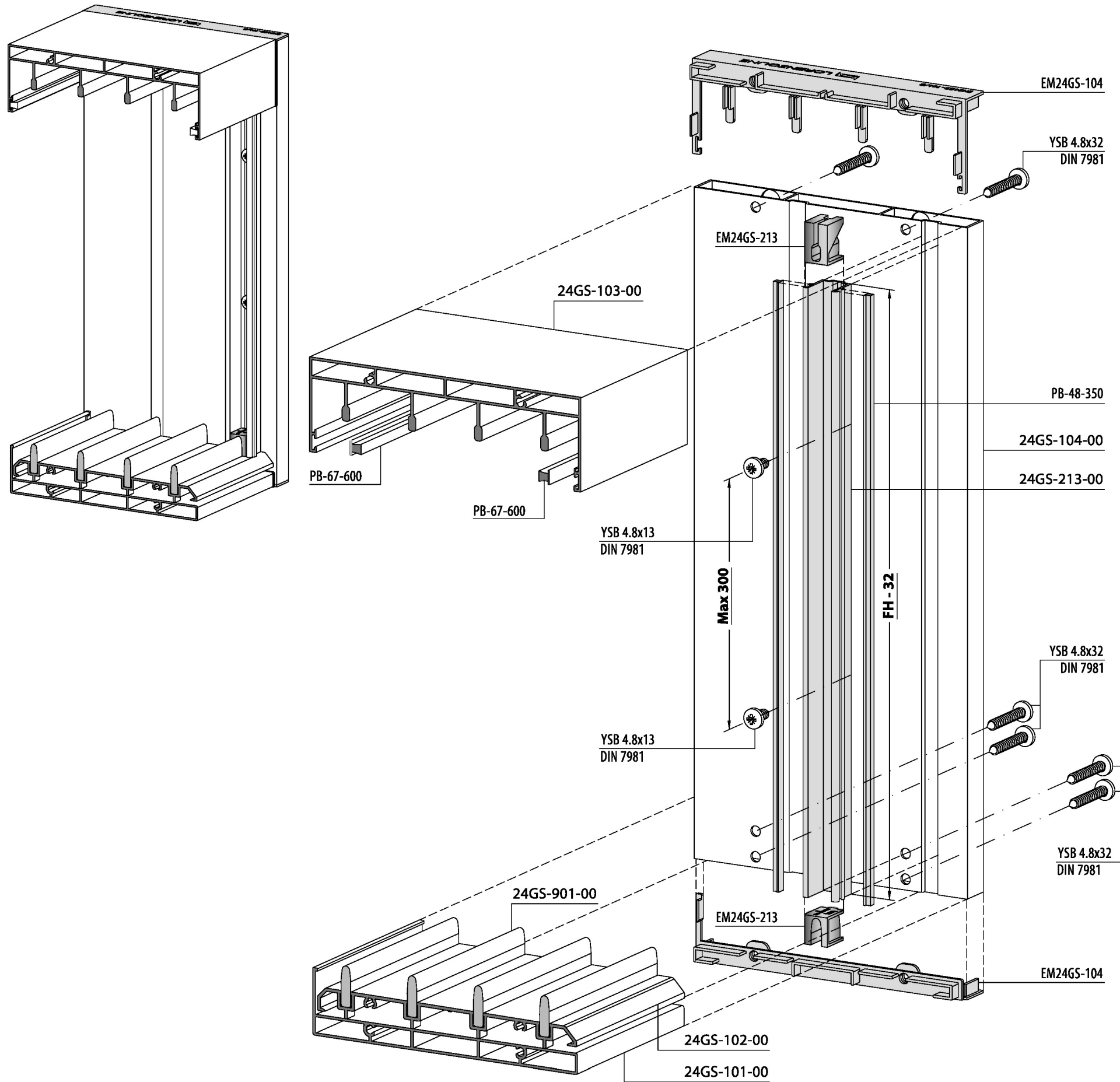

**EM24GS-213**  
**FRAME ISOLATION PLASTIC SET**  
 KASA KÖŞE İZOLASYON  
 PLASTİK TAKIMI



**EM24GS-104**  
**FRAME CORNER CONNECTION PLASTIC SET**  
 ALT VE ÜST KASA KÖŞE  
 BİRLEŞİM PLASTİK TAKIMI



HOLES / DELİK

24GS-104-00

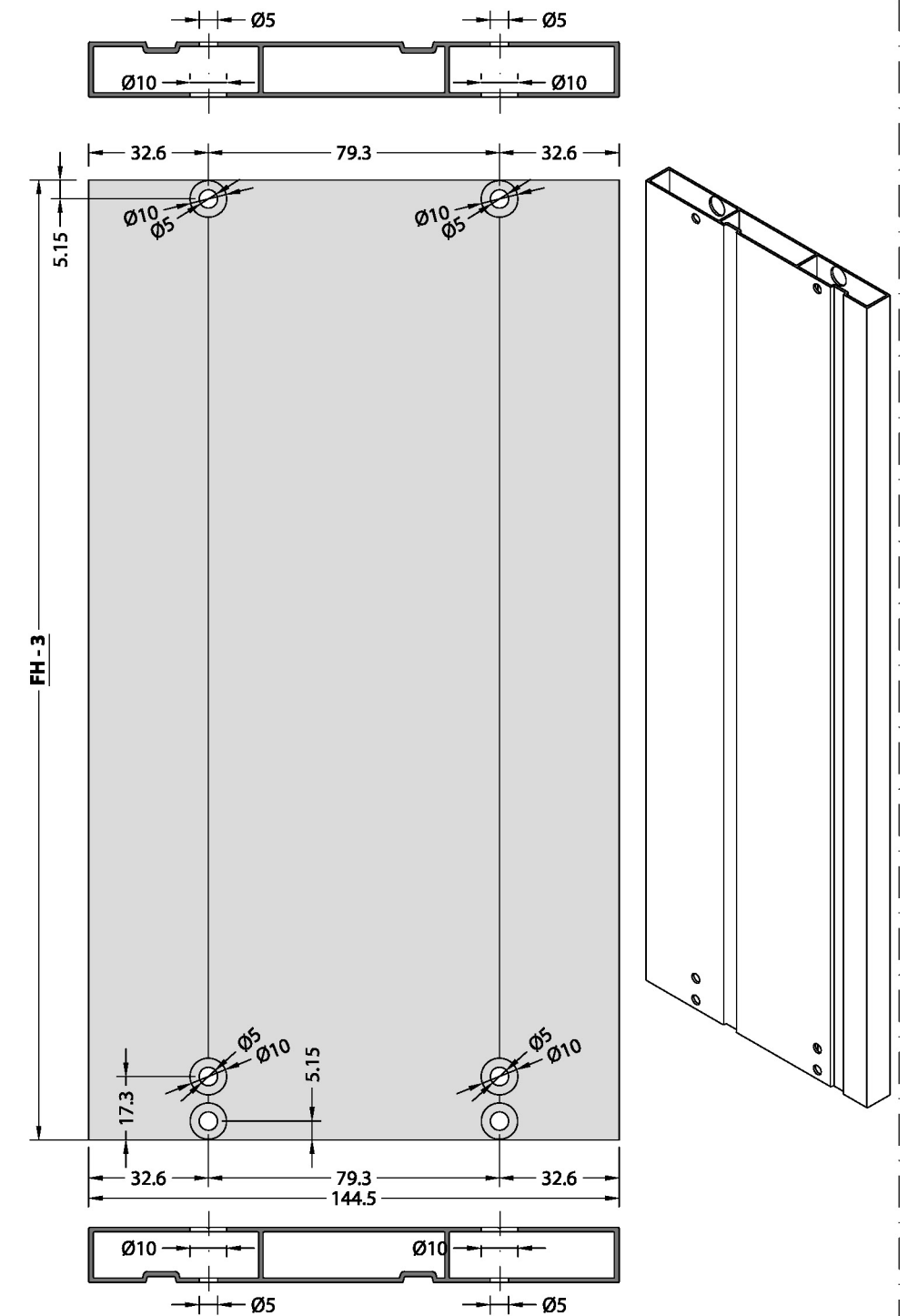

**WITHOUT BOTTOM FRAME APPLICATION / ALT KASASIZ UYGULAMA**

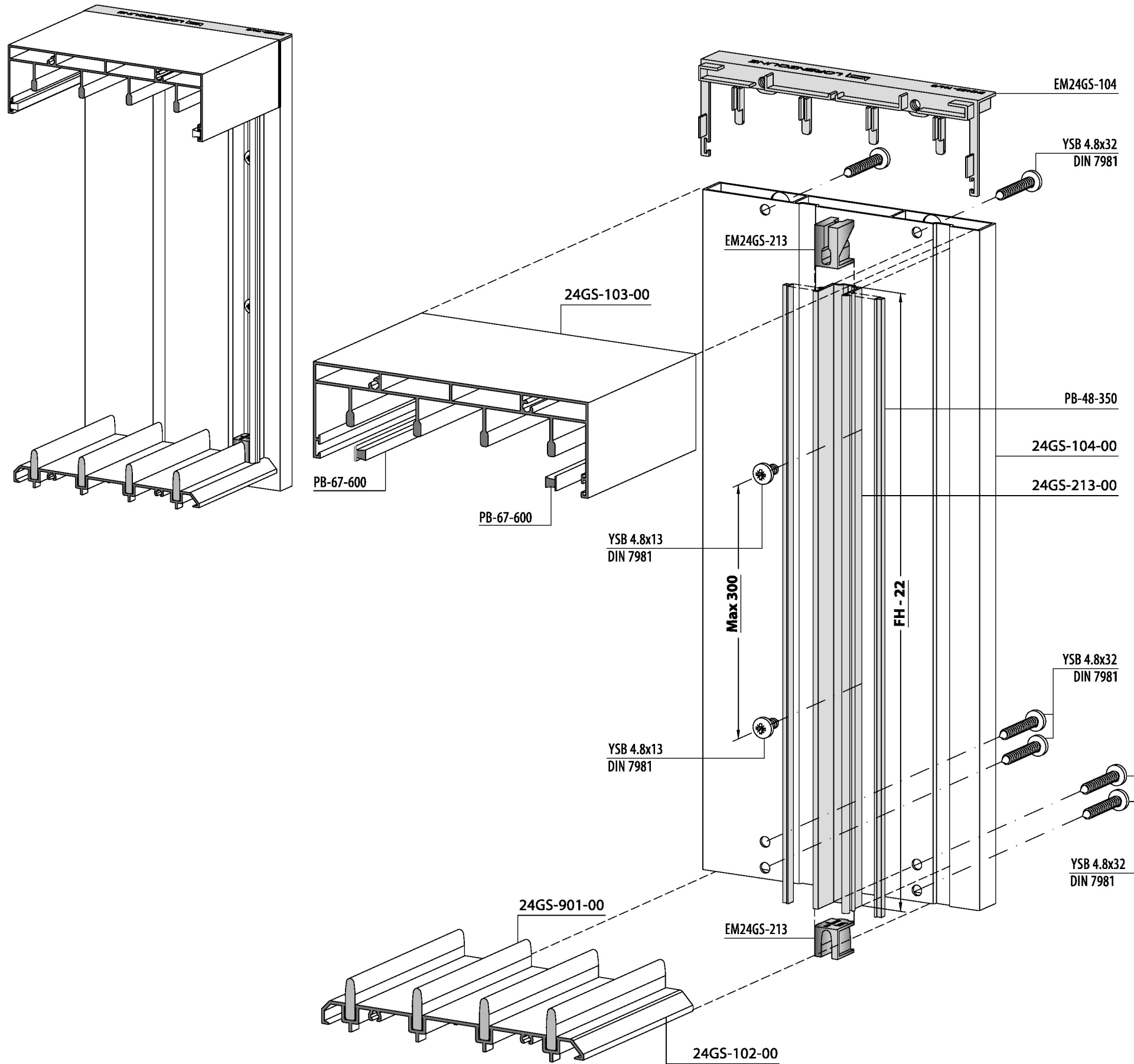

**EM24GS-213**  
FRAME ISOLATION PLASTIC SET  
KASA KÖŞE İZOLASYON  
PLASTİK TAKIMI



**EM24GS-104**  
FRAME CORNER  
CONNECTION PLASTIC SET  
ALT VE ÜST KASA KÖŞE  
BİRLEŞİM PLASTİK TAKIMI



**HOLES / DELİK** **24GS-104-00**

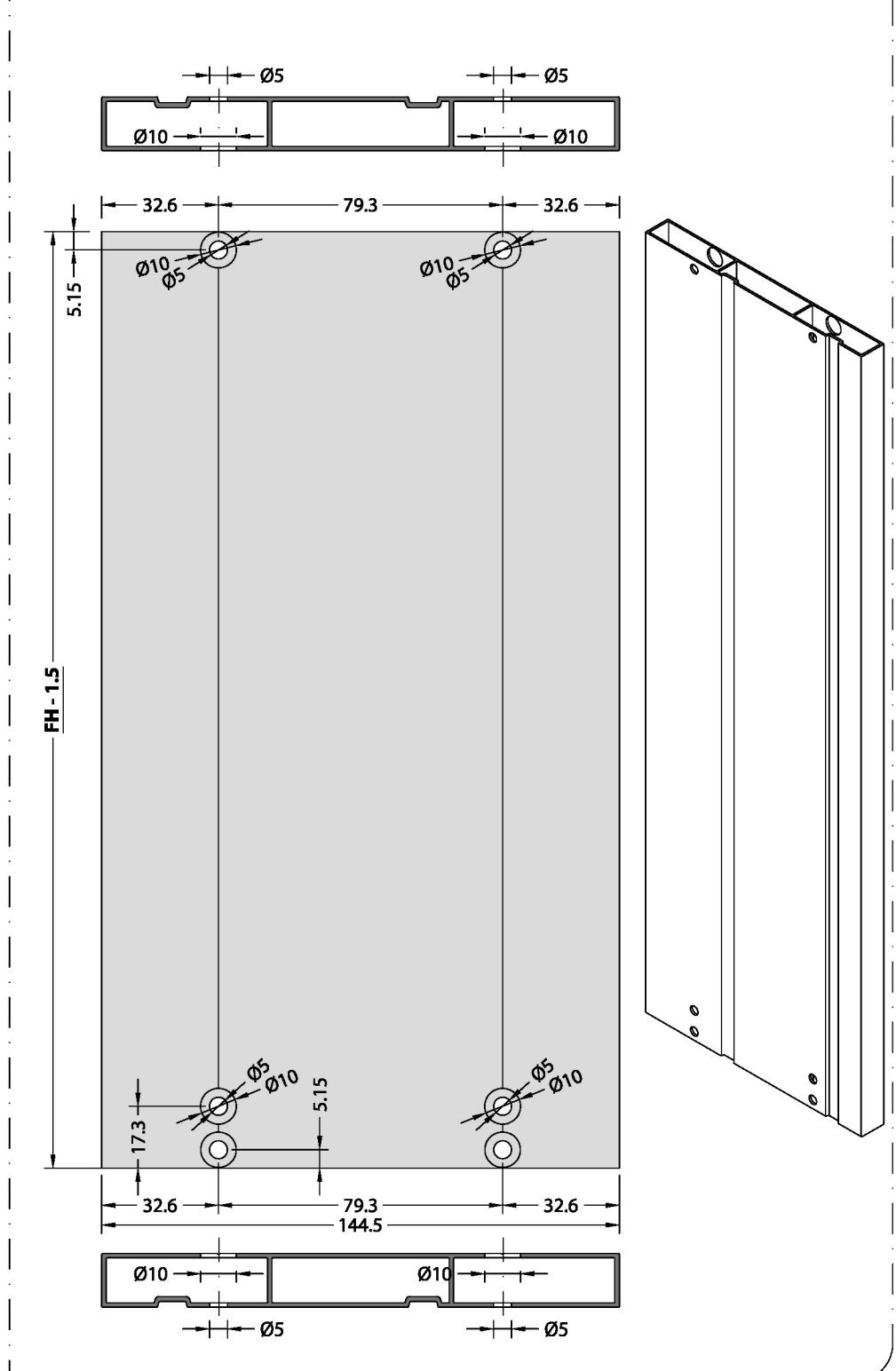

**SASH PROFILE MECHANICAL TREATMENTS  
KANAT PROFİLİ MEKANİK İŞLEMLERİ**

**EM24GS-201**  
**SASH CONNECTION**  
**PLASTIC SET**  
KANAT BİRLEŞİM  
PLASTİK TAKIMI

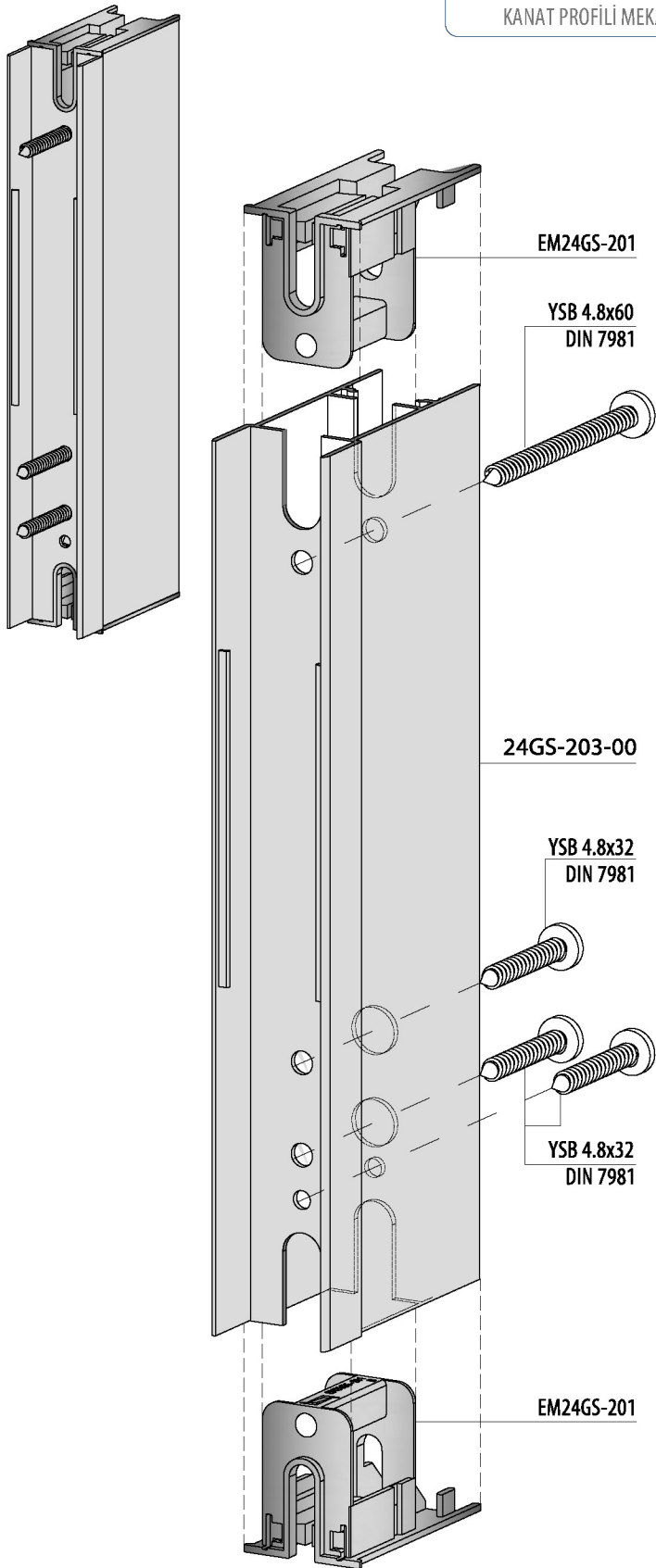

**NOTCH / KERME**

**24GS-203-00**

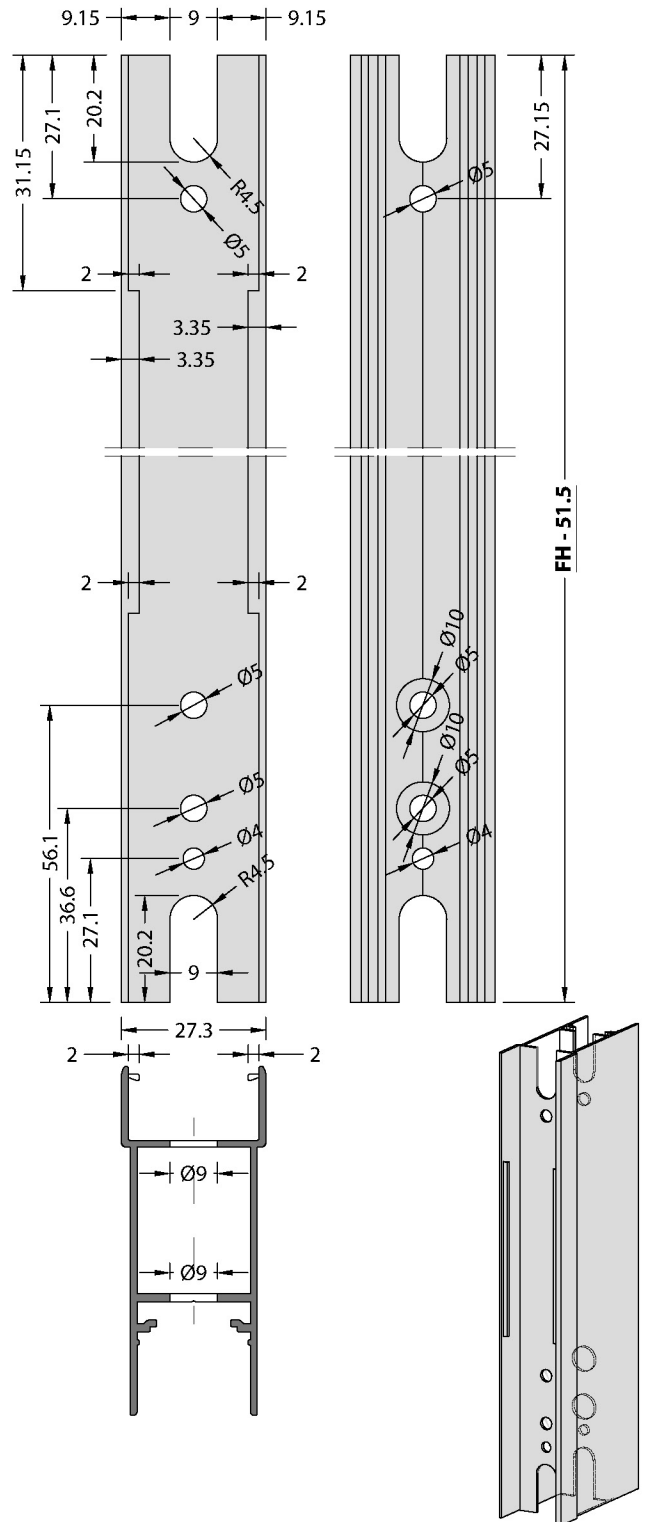

**CLAMP PROFILE MECHANICAL TREATMENTS  
KENET PROFİLİ MEKANİK İŞLEMLERİ**

**EM24GS-501**  
**CLAMP CONNECTION  
PLASTIC SET**  
KENET  
PLASTİK TAKIMI

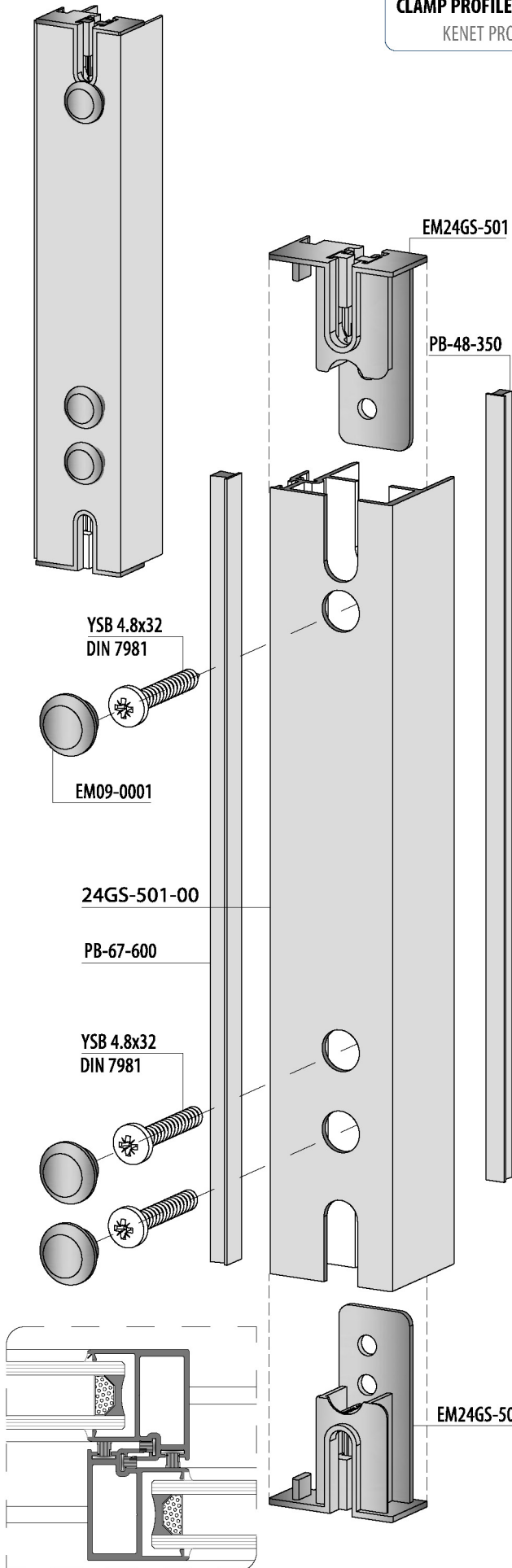

**NOTCH / KERME**

**24GS-501-00**

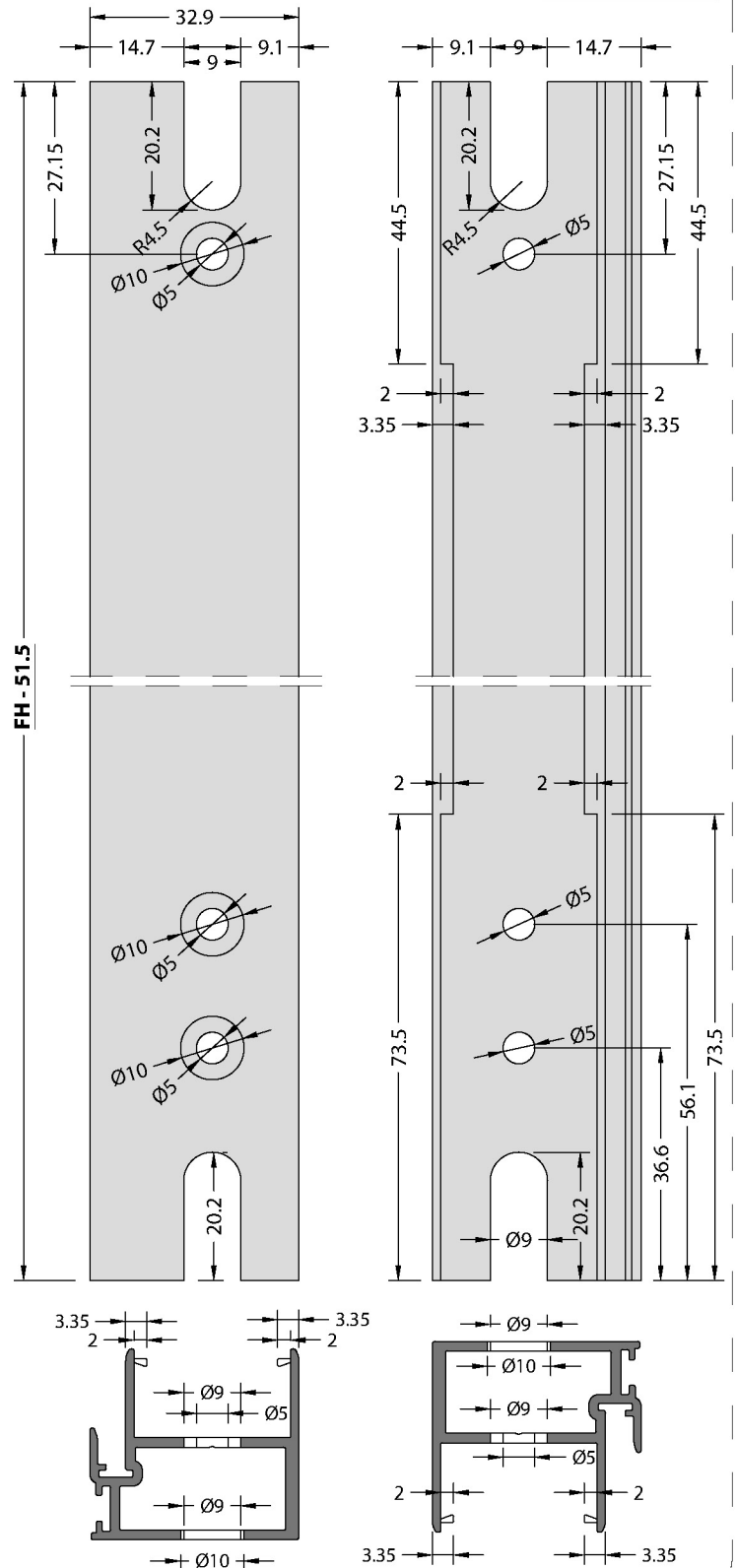

PASSIVE SASH PROFILE MECHANICAL TREATMENTS / PASİF KANAT PROFİLİ MEKANİK İŞLEMLERİ

**EM24GS-204**  
**HEAD TO HEAD**  
**CONNECTION PLASTIC SET**  
 Kafa Kafaya  
 PLASTİK TAKIMI

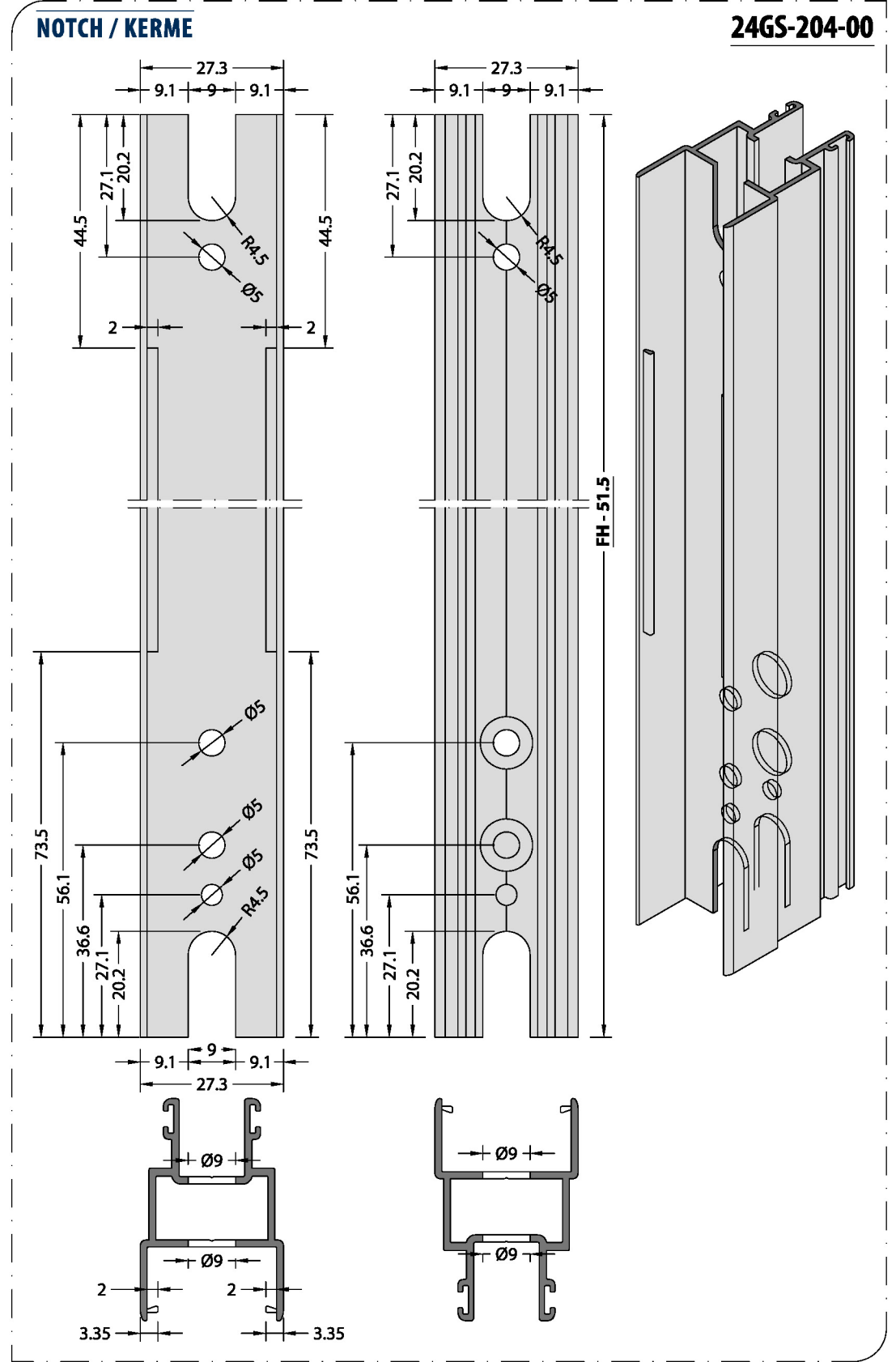
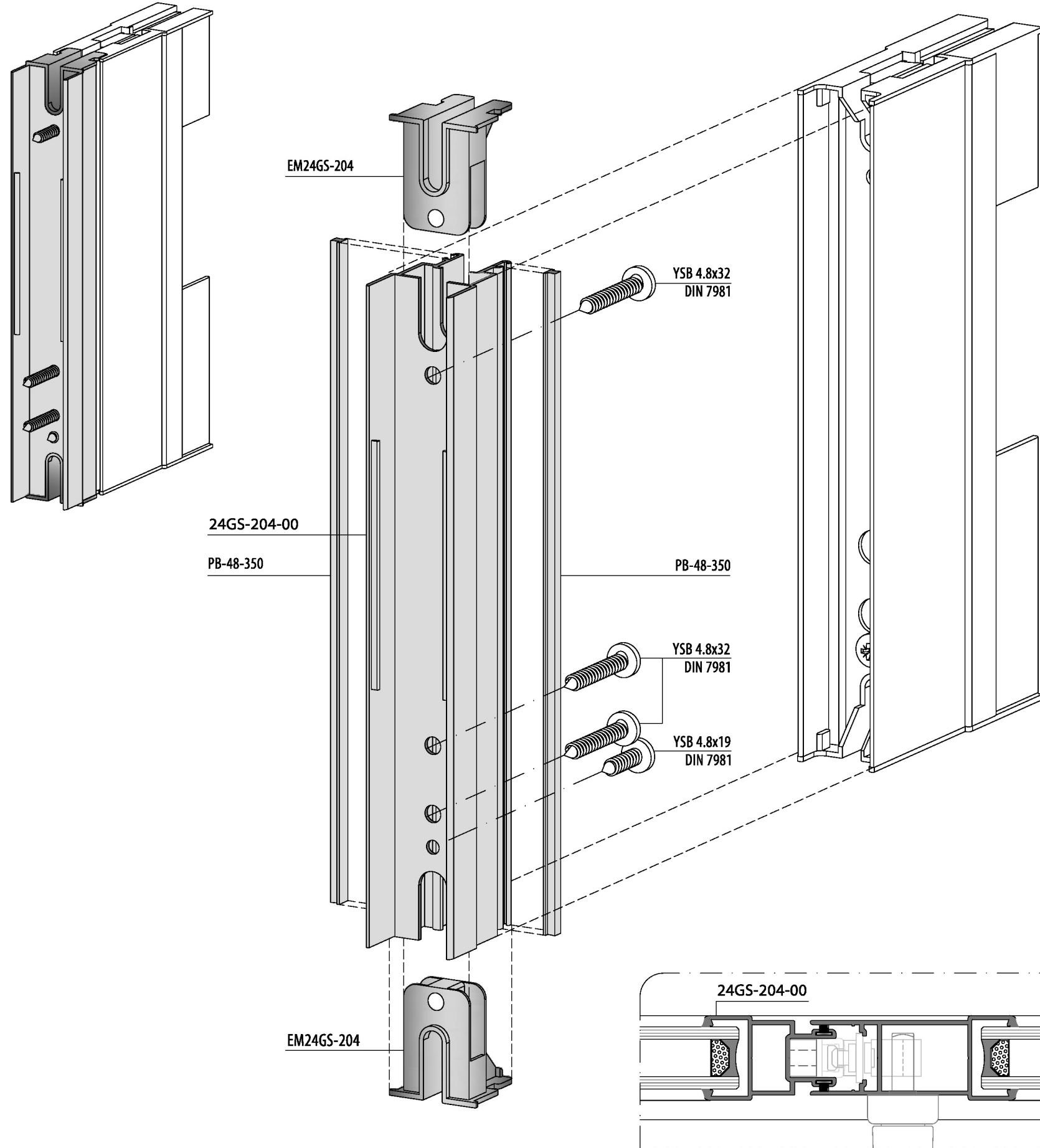

**FIRST SASH APPLICATION / İLK KANAT UYGULAMA**

**EM24GS-501**  
CLAMP CONNECTION  
PLASTIC SET  
KENET  
PLASTİK TAKIMI



**EM24GS-201**  
SASH CONNECTION  
PLASTIC SET  
KANAT BİRLEŞİM  
PLASTİK TAKIMI

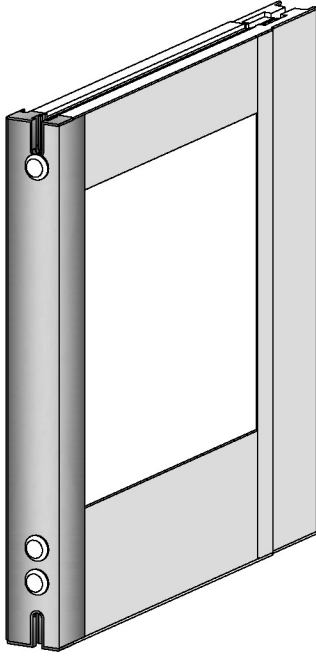

YSB 4.8x32  
DIN 7981  
EM09-0001

PB-67-600

24GS-501-00

PB-48-350

YSB 4.8x32  
DIN 7981  
EM09-0001

EM24GS-501

24GS-202-00

EM24GS-201

YSB 4.8x60  
DIN 7981

24GS-203-00

YSB 4.8x32  
DIN 7981

EM24GS-201

24GS-201-00

EM24GS-501

**MID SASH APPLICATION / ORTA KANAT UYGULAMA**

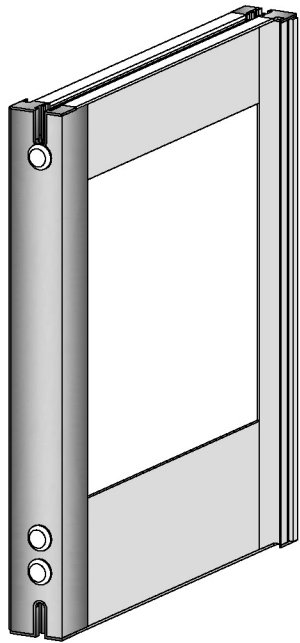

**EM24GS-501**  
**CLAMP CONNECTION**  
**PLASTIC SET**  
 KENET PLASTİK TAKIMI

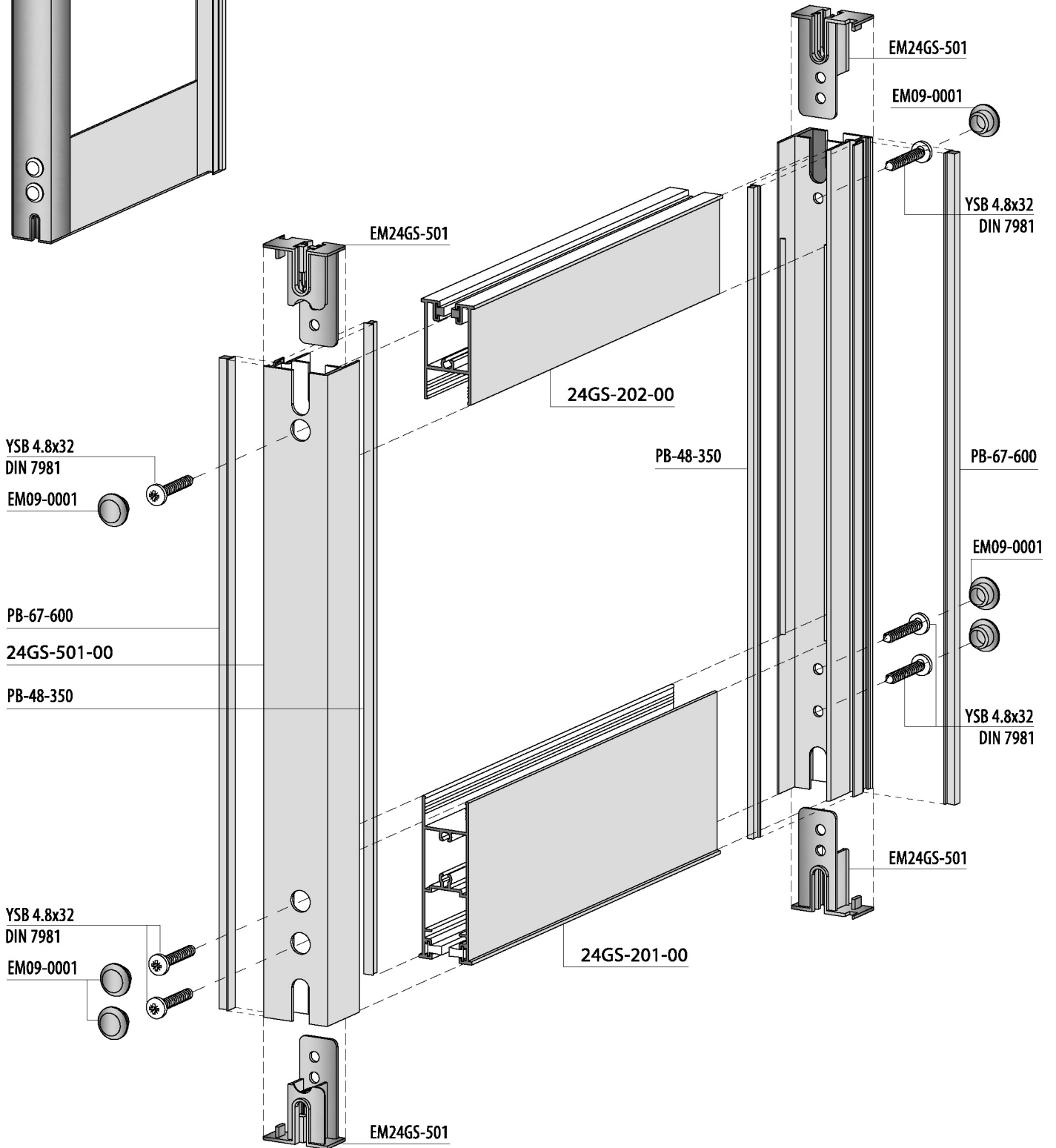

**PASSIVE SASH APPLICATION / PASİF KANAT UYGULAMA**

**EM24GS-501**  
CLAMP CONNECTION  
PLASTIC SET  
KENET  
PLASTİK TAKIMI



**EM24GS-204**  
HEAD TO HEAD  
CONNECTION PLASTIC SET  
KAFA KAFAYA  
PLASTİK TAKIMI

